



# **GCOR**

## **General Code of Operating Rules**

**Sixth Edition**

**Effective April 7, 2010**

**These rules herein govern the operations of the railroads listed and must be complied with by all employees regardless of gender whose duties are in any way affected thereby. They supersede all previous rules and instructions inconsistent therewith.**

**© 2010 General Code of Operating Rules Committee, All Rights Reserved**

**Revised Edition**

This version is updated to include BNSF's amendments through April 7, 2010. The following pages are revised or added:

**April 7, 2010:** Cover page, i-2, i-5, i-6, i-7, i-8, i-9, i-10, 1-5, 1-6, 1-7, 1-8, 1-13, 1-14, 1-15, 1-16, 2-3, 2-4, 5-3, 5-4, 5-5, 5-6, 5-7, 5-8, 5-9, 5-10, 5-13, 5-14, 5-19, 5-20, 6-1, 6-2, 6-3, 6-4, 6-5, 6-6, 6-11, 6-12, 6-13, 6-14, 6-15, 6-16, 6-17, 6-18, 7-1, 7-2, 7-3, 7-4, 8-7, 8-8, 9-3, 9-4, 9-9, 9-10, 10-1, 10-2, 10-3, 10-4, 13-1, 13-2, 13-3, 13-4, 14-3, 14-4, 14-5, 14-6, 14-7 (added), 14-8 (added), 15-1, 15-2, 15-3, 15-4, 15-5, 15-6, 20-1 (added), 20-2 (added), GL-1, GL-2, GL-3, GL-4.

**Adopted by:**

Acadiana Railway Company  
 Adrian & Blissfield Rail Road Company  
 Alabama & Gulf Coast Railway  
 Alabama Southern Railroad  
 Alabama & Tennessee River Railway, LLC  
 Alabama Warrior Railroad  
 Alaska Railroad Corporation  
 Albany & Eastern Railroad Company  
 Aliquippa & Ohio River Railroad  
 Alliance Terminal Railway, LLC  
 Altamont Commuter Express Rail Authority  
 Alton & Southern Railway  
 Amtrak—Chicago Terminal  
 Amtrak—Michigan Line  
 Amtrak—NOUPT  
 AN Railway  
 Apache Railway Company  
 A&R Terminal Railroad Company  
 Arizona & California Railroad  
 Arizona and California Railway Company  
 Arizona Central Railroad  
 Arizona Eastern Railway Company  
 Arkansas Louisiana & Mississippi Railroad  
 Arkansas Midland Railroad Company Inc.  
 Arkansas & Missouri Railroad Company  
 Arkansas Southern Railroad  
 Ashtabula, Carson & Jefferson Railroad  
 AT&L Railroad Company  
 Atlantic & Western Railway  
 Austin Western Railroad  
 Baton Rouge Southern Railroad  
 Bauxite & Northern Railway  
 Bay Line Railroad  
 Belt Railway Company of Chicago  
 BHP Nevada Railway Company  
 Blackwell Northern Gateway Railroad  
 BNSF Railway  
 Boise Valley Railroad  
 Buckingham Branch Railroad  
 Buffalo & Pittsburg Railroad  
 California Northern Railroad  
 California Western Railroad  
 Camas Prairie RailNet, Inc.  
 Canadian Pacific  
 Caney Fork & Western Railroad  
 Canon City and Royal Gorge Railroad  
 Carolina Piedmont Railroad  
 Carrizo Gorge Railway  
 Cascade and Columbia River Railroad  
 Cedar Rapids & Iowa City Railway Company  
 Central California Traction Company  
 Central Illinois Railroad  
 Central Kansas Railway  
 Central Midland Railway  
 Central Montana Rail  
 Central Oregon & Pacific Railroad, Inc.  
 Central Railroad of Indiana  
 Central Railroad of Indianapolis  
 Charlotte Southern Railroad Company  
 Chattahoochee Bay Railroad  
 Chattahoochee Industrial Railroad  
 Chattooga & Chickamauga Railway  
 Chesapeake & Albemarle Railroad Company, Inc.  
 Chicago, Ft. Wayne & Eastern Railroad  
 Chicago Rail Link  
 Chicago SouthShore & South Bend Railroad  
 City of Prineville Railway  
 C&NC Railroad Corporation  
 Columbia Basin Railroad Co.  
 Columbia and Cowlitz Railway  
 Columbia Terminal  
 Columbus & Greenville Railway  
 Columbus & Ohio River Railroad  
 Commonwealth Railway  
 Connecticut Southern Railroad

Corpus Christi Terminal Railroad  
Council Bluffs Railway  
D&I Railroad  
Dakota, Minnesota & Eastern Railroad  
Dakota, Missouri Valley & Western Railroad, Inc.  
Dakota Southern Railway  
Dallas, Garland & Northeastern Railroad, Inc.  
Dardanelle & Russellville Railroad  
Decatur Junction Railway Company  
Denver Rock Island Railroad  
DeQueen & Eastern Railroad Company  
Detroit Connecting Railroad Company  
East Tennessee Railway  
Eastern Alabama Railway  
Eastern Idaho Railroad  
Ellis & Eastern Company  
Escanaba & Lake Superior Railroad  
Farmrail Corporation  
First Coast Railroad  
Florida East Coast Railway  
Fordyce & Princeton Railroad  
Fort Worth & Western Railroad  
Fox Valley & Western  
Fulton County Railway, LLC  
Galveston Railroad  
Gateway Western Railway  
Georgetown Railroad Company  
Georgia Central Railway  
Georgia & Florida Railway  
Georgia Southwestern Railroad, Inc.  
Georgia Woodlands Railroad  
Golden Isles Terminal Railroad  
Golden Triangle Railroad  
Grain Belt Corp  
Grand Canyon Railway  
Grand Elk Railroad  
Grand Rapids Eastern Railroad  
Great Northwest Railroad  
Great Western Railway  
Gulf Colorado & San Saba Railroad  
Huron and Eastern Railway Company, Inc.  
Hutchinson and Northern Railway Company  
Idaho Northern & Pacific Railroad Company  
Illinois & Midland Railroad, Inc.  
Illinois Railway, Inc.  
Indiana & Ohio Railway  
Indiana Rail Road Company  
Indiana Southern Railroad, Inc.  
International Bridge & Terminal Company  
Iowa Chicago & Eastern Railroad  
Iowa Interstate Railroad Ltd.  
Iowa Northern Railway Company  
Jaxport Terminal Railway  
Kansas City Southern Railway  
Kansas City Terminal Railway Company  
Kansas & Oklahoma Railroad  
Kaw River Railroad  
Kentucky West Tennessee Railway  
Keokuk Junction Railway Company  
Kettle Falls International Railway, LLC  
Kiamichi Railroad  
Kyle Railroad Company  
Lahaina Kaanapali & Pacific Railroad  
Lake Superior and Ishpeming Railroad  
Lapeer Industrial Railroad Company  
Lewis and Clark Railway Company  
Little Rock and Western Railway, LP  
Longview Switching Company  
Los Angeles Junction Railway  
Louisiana and Delta Railroad Company  
Louisiana Southern Railroad  
Luxapalila Valley Railroad  
Mahoning Valley Railroad  
Manufacturers Junction Railway  
Maryland Midland Railway  
Maumee & Western Railroad

McCloud Railway Company  
Meridian and Bigbee Railroad  
Meridian Southern Railway, LLC  
Messena Terminal Railroad Company  
Michigan Air-Line Railway Company  
Michigan Central Railway  
Michigan Shore Railroad  
Mid-Michigan Railroad, Inc.  
Minnesota Commercial Railway Company  
Minnesota, Dakota & Western Railway Company  
Minnesota Northern Railroad, Inc.  
Minnesota Prairie Line Incorporated  
Minnesota Southern Railway  
Minnesota Valley Transportation Company  
Mission Mountain Railroad  
Mississippi Southern Railroad  
Mississippi & Tennessee RailNet, Inc.  
Mississippi Tennessee Railroad  
Missouri & Northern Arkansas RR Company, Inc.  
Missouri & Valley Park Railroad  
Modesto & Empire Traction Company  
Montana Rail Link  
Mount Vernon Terminal Railway, Inc.  
Napa Valley Railroad Company  
Nashville and Eastern Railroad  
Nashville and Western Railroad  
National Coal Rail Line  
Nebkota Railway, Inc.  
Nebraska Central Railroad Company  
Nebraska Kansas Colorado Railway, Inc.  
Nebraska Northeastern Railway Company  
New England Central Railroad, Inc.  
New Mexico Rail Runner Express  
New Orleans & Gulf Coast Railway Company  
New Orleans Lower Coast Railroad  
New Orleans Public Belt Railroad  
Newburgh & South Shore Railroad Company  
New York & Atlantic Railway  
North Carolina & Virginia Railroad Company, Inc.  
Northeast Illinois Regional Commuter Railroad Corp.  
Northern Indiana Commuter Transportation District  
Northern Lines Railway  
Northern Ohio & Western Railway  
Northern Plains Railroad  
Ohio & Pennsylvania Railroad  
Ohio Central Railroad  
Ohio Southern Railroad  
Omaha, Lincoln & Beatrice Railway Company  
Osceola and St. Croix Valley Railroad Company  
Otter Tail Valley Railroad Company, Inc.  
Pacific Harbor Line  
Pacific Sun Railroad  
Palouse River and Coulee City Railroad  
Panhandle Northern Railroad  
Pecos Valley Southern Railway Company  
Pend Oreille Valley Railroad  
Peninsula Corridor Joint Powers Board (Caltrain)  
Pennsylvania Southwestern Railroad  
Pittsburgh Industrial Railroad  
Pittsburgh & Ohio Central Railroad  
Point Comfort & Northern Railway Company  
Port Bienville Railroad  
Port of Tillamook Bay Railroad  
Portland & Western Railroad  
Portland Terminal Railroad Company  
Progressive Rail Inc.  
Puget Sound & Pacific Railroad  
Rarus Railway, Inc.  
Red River Valley & Western Railroad Co.  
Riceboro Southern Railway  
Richmond Pacific Railroad  
Richmond Terminal Railroad Company  
Rio Valley Switching Company  
Rochester & Southern Railroad  
Rockdale, Sandow & Southern Railroad Company  
Saginaw Valley Railroad Company

San Diego & Imperial Valley Railroad Company, Inc.  
San Diego Northern Railway  
San Francisco Bay Railroad  
San Joaquin Valley Railroad Co., Inc.  
San Luis Central Railroad Company  
San Pedro and Southwestern Railway Company  
Sand Springs Railway Company  
Santa Cruz, Big Trees & Pacific Railway Company  
Santa Fe Southern Railway, Inc.  
Sault Ste. Marie Bridge Company  
Savage Bingham & Garfield Railroad Company  
Savannah Port Terminal Railroad  
SEMO Port Railroad  
Sierra Railroad Company  
South Buffalo Railway  
South Carolina Central Railroad Company, Inc.  
South Central Tennessee Railroad  
South East Kansas Railroad  
South Kansas and Oklahoma Railroad  
South Plains Lamesa Railroad Ltd.  
Southern California Regional Rail Authority  
Southern Switching Company  
Southwestern Railroad Company, Inc.  
St. Croix Valley Railroad Company  
St. Maries River Railroad Company  
Stillwater Central Railroad  
Tacoma Municipal Belt Line Railway  
Talleyrand Terminal Railroad  
Tazewell & Peoria Railroad  
Tecumseh Branch Connecting Railroad Company  
Tennessee Valley Railroad Museum, Inc  
Tennken Railroad Company Inc.  
Terminal Railroad Association of St. Louis  
Texas - New Mexico Division  
Texas North Western Railway Company  
Texas Northeastern Railroad  
Texas, Gonzales & Northern Railway Company  
Texas Rock Crusher Railway Co.  
Timber Rock Railroad  
Toledo, Peoria & Western Railway  
Tomahawk Railroad  
Transportación Ferroviaria Mexicana  
Trinity Railway Express  
Trona Railway Company  
Tulare Valley Railroad  
Tulsa-Sapulpa Union Railway Company  
Twin Cities & Western Railroad Company  
Union Pacific Railroad  
United States Army Military Railroad System  
Utah Central Railway  
Utah Railway Company  
Utah Transit Authority  
V&S Railroad Inc.  
Valdosta Railway  
Ventura County Railway Company  
Verde Canyon Railroad  
Vicksburg Southern Railroad  
Virginia Southern Division  
Wabash Central Railroad  
Warren & Trumbull Railroad  
WATCO Transportation Services  
West Tennessee Railroad, LLC  
West Tennken Railroad Corp.  
West Texas and Lubbock Railroad  
Wichita, Tillman & Jackson Railway  
Willamette & Pacific Railroad, Inc.  
Willamette Valley Railroad  
Willamina and Grand Ronde Railway  
Wilmington Terminal Railroad  
Wisconsin & Southern Railroad Company  
Wyoming/Colorado Railroad Company  
Yellowstone Valley Railroad  
York Railway  
Youngstown & Austintown Railroad  
Youngstown Belt railroad  
Yreka Western Railroad

## Table of Contents

<b>1.0</b>	<b>General Responsibilities.....</b>	<b>1-1</b>		
1.1	Safety.....	1-1		
1.1.1	Maintaining a Safe Course.....	1-1		
1.1.2	Alert and Attentive.....	1-1		
1.1.3	Accidents, Injuries, and Defects.....	1-1		
1.1.4	Condition of Equipment and Tools.....	1-1		
1.2	Personal Injuries and Accidents.....	1-1		
1.2.1	Care for Injured.....	1-1		
1.2.2	Witnesses.....	1-1		
1.2.3	Equipment Inspection.....	1-2		
1.2.4	Mechanical Inspection.....	1-2		
1.2.5	Reporting.....	1-2		
1.2.6	Statements.....	1-2		
1.2.7	Furnishing Information.....	1-2		
1.3	Rules.....	1-3		
1.3.1	Rules, Regulations, and Instructions.....	1-3		
1.3.2	General Orders.....	1-3		
1.3.3	Circulars, Instructions, and Notices.....	1-3		
1.4	Carrying Out Rules and Reporting Violations.....	1-4		
1.4.1	Good Faith Challenge.....	1-4		
1.5	Drugs and Alcohol.....	1-5		
1.6	Conduct.....	1-5		
1.6.1	Motor Vehicle Driving Records.....	1-6		
1.6.2	Notification of Felony Convictions.....	1-6		
1.6.3	Notification of Deteriorating Vision or Hearing.....	1-6		
1.7	Altercations.....	1-6		
1.8	Appearance.....	1-6		
1.9	Respect of Railroad Company.....	1-6		
1.10	Games, Reading, or Electronic Devices.....	1-6		
1.11	Sleeping.....	1-8		
1.11.1	Napping.....	1-8		
1.12	Weapons.....	1-8		
1.13	Reporting and Complying with Instructions.....	1-9		
1.14	Employee Jurisdiction.....	1-9		
1.15	Duty - Reporting or Absence.....	1-9		
1.16	Subject to Call.....	1-9		
1.17	Hours of Service Law.....	1-9		
1.18	Unauthorized Employment.....	1-9		
1.19	Care of Property.....	1-10		
1.20	Alert to Train Movement.....	1-10		
1.21	Occupying Roof.....	1-10		
1.22	Not Permitted on Equipment.....	1-10		
1.23	Altering Equipment.....	1-10		
1.24	Clean Property.....	1-10		
1.25	Credit or Property.....	1-10		
1.26	Gratuities.....	1-10		
1.27	Divulging Information.....	1-11		
1.28	Fire.....	1-11		
1.29	Avoiding Delays.....	1-11		
1.30	Riding Engine.....	1-11		
1.31	Repairs to Foreign Cars.....	1-11		
1.32	Overheated Wheels.....	1-11		
1.33	Inspection of Freight Cars.....	1-12		
1.34	Flat Spots.....	1-12		
1.35	Dump Doors.....	1-12		
1.36	Excessive Dimension Loads.....	1-13		
1.37	Open Top Loads.....	1-13		
1.38	Shipments Susceptible to Damage.....	1-13		
1.39	Accuracy of Speed Indicator.....	1-13		
1.40	Reporting Engine Defects.....	1-13		
1.41	Engines Coupled to Occupied Passenger Cars.....	1-14		
1.42	Trains Detoured.....	1-14		
1.43	Stopped in Tunnels.....	1-14		
1.44	Duties of Train Dispatchers.....	1-14		
1.45	Duties of Control Operators and Operators.....	1-14		
1.46	Duties of Yardmasters.....	1-15		
1.47	Duties of Crew Members.....	1-15		
1.48	Time.....	1-16		
<b>2.0</b>	<b>Railroad Radio Rules.....</b>	<b>2-1</b>		
2.1	Transmitting.....	2-1		
2.2	Required Identification.....	2-1		
2.3	Repetition.....	2-1		
2.4	Ending Transmissions.....	2-1		
2.5	Communication Redundancy.....	2-2		
2.6	Communication Not Understood or Incomplete.....	2-2		
2.7	Monitoring Radio Transmissions.....	2-2		
2.8	Acknowledgment.....	2-2		
2.9	Misuse of Radio Communications.....	2-2		
2.10	Emergency Calls.....	2-2		
2.11	Prohibited Transmissions.....	2-3		
2.12	Fixed Signal Information.....	2-3		
2.13	Not Used.....	2-3		
2.14	Transmission of Mandatory Directives.....	2-3		
2.14.1	Verbally Transmitting and Repeating Mandatory Directives.....	2-3		
2.14.2	Before Reporting Clear of Authority Limits.....	2-4		
2.15	Phonetic Alphabet.....	2-4		
2.16	Assigned Frequencies.....	2-4		
2.17	Radio Testing.....	2-4		
2.18	Malfunctioning Radio.....	2-4		
2.19	Blasting Operations.....	2-4		
2.20	Internal Adjustments.....	2-4		
<b>3.0</b>	<b>Section Reserved.....</b>	<b>3-1</b>		

<b>4.0</b>	<b>Timetables.....</b>	<b>4-1</b>		
4.1	New Timetable.....	4-1	5.14	Signs Protecting Equipment.....
	4.1.1 Notice of New Timetable.....	4-1	5.15	Improperly Displayed Signals.....
4.2	Special Instructions.....	4-1		
4.3	Timetable Characters.....	4-1	<b>6.0</b>	<b>Movement of Trains and Engines.....</b>
<b>5.0</b>	<b>Signals and Their Use.....</b>	<b>5-1</b>	6.1	Repeat Instructions.....
5.1	Signal Equipment.....	5-1	6.2	Initiating Movement.....
5.2	Receiving and Giving Signals.....	5-1		6.2.1 Train Location.....
	5.2.1 Looking for Signals.....	5-1	6.3	Main Track Authorization.....
	5.2.2 Signals Used by Employees.....	5-1		6.3.1 Train Coordination.....
5.3	Hand and Radio Signals.....	5-2	6.4	Reverse Movements.....
	5.3.1 Hand Signals.....	5-2		6.4.1 Permission for Reverse Movements....
	5.3.2 Giving Signals.....	5-2		6.4.2 Movements Within Control Points or
	5.3.3 Signal Disappearance.....	5-2		Interlockings.....
	5.3.4 Signal to Stop.....	5-2	6.5	Shoving Movements.....
	5.3.5 Acknowledge Stop Signal.....	5-2		6.5.1 Remote Control Movements.....
	5.3.6 Radio and Voice Communication.....	5-2	6.6	Picking Up Crew Member.....
	5.3.7 Radio Response.....	5-3	6.7	Remote Control Zone.....
5.4	Flags for Temporary Track Conditions.....	5-3	6.8	Stopping Clear for Meeting or Passing.....
	5.4.1 Temporary Restrictions.....	5-3	6.9	Meeting or Passing Precautions.....
	5.4.2 Display of Yellow Flag.....	5-3	6.10	Instructions to Clear a Following Train.....
	5.4.3 Display of Yellow-Red Flag.....	5-4	6.11	Mandatory Directive.....
	5.4.4 Authorized Protection by Yellow or		6.12	FRA Excepted Track.....
	Yellow-Red Flag.....	5-5	6.13	Yard Limits.....
	5.4.6 Display of Flags Within Current of		6.14	Restricted Limits.....
	Traffic.....	5-6	6.15	Block Register Territory (BRT).....
	5.4.5 Display of Green Flag.....	5-6	6.16	Approaching Railroad Crossings,
	5.4.7 Display of Red Flag or Red Light.....	5-7		Drawbridges, and End of Multiple Main Track....
	5.4.8 Flag Location.....	5-7	6.17	Switches at Junctions.....
5.5	Permanent Speed Signs.....	5-7	6.18	Stopping Clear of Crossings and Junctions.....
5.6	Unattended Fusee.....	5-8	6.19	Flag Protection.....
5.7	Not Used.....	5-8	6.20	Equipment Left on Main Track.....
5.8	Bell and Whistle Signals.....	5-8	6.21	Precautions Against Unusual Conditions.....
	5.8.1 Ringing Engine Bell.....	5-8		6.21.1 Protection Against Defects.....
	5.8.2 Sounding Whistle.....	5-9		6.21.2 Water Above Rail.....
	5.8.3 Whistle Failure.....	5-9	6.22	Maintaining Control of Train or Engine.....
	5.8.4 Whistle Quiet Zone.....	5-10	6.23	Emergency Stop or Severe Slack Action.....
5.9	Headlight Display.....	5-10	6.24	Movement on Double Track.....
	5.9.1 Dimming Headlight.....	5-10	6.25	Movement Against the Current of Traffic.....
	5.9.2 Headlight Off.....	5-11	6.26	Use of Multiple Main Tracks.....
	5.9.3 Headlight Failure.....	5-11	6.27	Movement at Restricted Speed.....
	5.9.4 Displaying Headlights Front and Rear.....	5-12	6.28	Movement on Other than Main Track.....
	5.9.5 Displaying Ditch Lights.....	5-12		6.28.1 Sidings of Assigned Direction.....
	5.9.6 Displaying Oscillating White Headlight.....	5-12		6.28.2 Stopping Clear in Siding.....
	5.9.7 Displaying Oscillating or Flashing			6.28.3 Cars or Equipment Left on Siding.....
	Red Light.....	5-12	6.29	Inspecting Trains.....
5.10	Markers.....	5-12		6.29.1 Inspecting Passing Trains.....
	5.10.1 Highly Visible Markers.....	5-13		6.29.2 Train Inspections by Crew Members ...
	5.10.2 Alternative Markers.....	5-13	6.30	Receiving or Discharging Passengers.....
5.11	Engine Identifying Number.....	5-13	6.31	Maximum Authorized Speed.....
5.12	Protection of Occupied Outfit Cars.....	5-14		6.31.1 Permanent Speed Restrictions.....
5.13	Blue Signal Protection of Workmen.....	5-17		

- 6.32 Road Crossings..... 6-16
  - 6.32.1 Providing Warning Over Road Crossings..... 6-16
  - 6.32.2 Automatic Warning Devices..... 6-16
  - 6.32.3 Providing Warning for Adjacent Tracks 6-18
  - 6.32.4 Clear of Crossings and Signal Circuits 6-18
  - 6.32.5 Actuating Automatic Warning Devices Unnecessarily ..... 6-18
  - 6.32.6 Blocking Public Crossings ..... 6-18

**7.0 Switching..... 7-1**

- 7.1 Switching Safely and Efficiently ..... 7-1
- 7.2 Communication Between Crews Switching..... 7-1
- 7.3 Additional Switching Precautions..... 7-1
- 7.4 Precautions for Coupling or Moving Cars or Engines ..... 7-2
- 7.5 Testing Hand Brakes..... 7-2
- 7.6 Securing Cars or Engines ..... 7-2
- 7.7 Kicking or Dropping Cars ..... 7-2
  - 7.7.1 Gravity Switch Moves ..... 7-2
- 7.8 Coupling or Moving Cars on Tracks Where Cars are Being Loaded or Unloaded..... 7-3
- 7.9 Switching Passenger or Occupied Outfit Cars... 7-3
- 7.10 Movement Through Gates or Doorways ..... 7-4
- 7.11 Charging Necessary Air Brakes ..... 7-4
- 7.12 Movements Into Spur Tracks ..... 7-4
- 7.13 Protection of Employees in Bowl Tracks ..... 7-4

**8.0 Switches ..... 8-1**

- 8.1 Hand Operation of Switches ..... 8-1
- 8.2 Position of Switches ..... 8-1
- 8.3 Main Track Switches ..... 8-1
- 8.4 Lining Main Track Switch ..... 8-2
- 8.5 Clearing Main Track Before Restoring Switch.... 8-2
- 8.6 Restoring Switch to Normal Position..... 8-2
- 8.7 Clear of Main Track Switches..... 8-2
- 8.8 Switches Equipped with Locks, Hooks or Latches..... 8-3
- 8.9 Movement Over Spring Switches..... 8-3
  - 8.9.1 Testing Spring Switch ..... 8-3
  - 8.9.2 Trailing Through and Stopping on a Spring Switch..... 8-4
  - 8.9.3 Hand Operating a Spring Switch Before Making a Trailing Movement .... 8-4
  - 8.9.4 During Snow or Ice Storms ..... 8-5
  - 8.9.5 Spiking Spring Switch ..... 8-5
  - 8.9.6 Approaching a Spring Switch in Non-Signaled Territory..... 8-5
- 8.10 Switch Point Indicator..... 8-5
- 8.11 Switches in Sidings ..... 8-5
- 8.12 Hand-Operated Crossover Switches..... 8-5
- 8.13 Scale Track Switches ..... 8-6
- 8.14 Conflicting Movements Approaching Switch ..... 8-6

- 8.15 Switches Run Through..... 8-6
- 8.16 Damaged or Defective Switches ..... 8-6
- 8.17 Avoid Sanding Over Moveable Parts ..... 8-6
- 8.18 Variable Switches ..... 8-6
- 8.19 Automatic Switches..... 8-6
  - 8.19.1 Radio Controlled Switches..... 8-7
- 8.20 Derail Location and Position ..... 8-7

**9.0 Block System Rules ..... 9-1**

- 9.1 Signal Aspects and Indications ..... 9-1
- 9.2 Location of Signals..... 9-1
- 9.3 What Signals Govern ..... 9-1
- 9.4 Improperly Displayed Signals or Absent Lights.. 9-1
- 9.5 Where Stop Must Be Made ..... 9-2
  - 9.5.1 Changing Established Route ..... 9-2
  - 9.5.2 Protection if Signal Appliance or Track is Damaged..... 9-2
  - 9.5.3 Protection During Repairs..... 9-2
  - 9.5.4 Authority to Proceed ..... 9-2
  - 9.5.5 Reporting Delays ..... 9-2
  - 9.5.6 Track Occupancy Indicator ..... 9-3
- 9.6 Change of Signal Indication ..... 9-3
- 9.7 Failure to Display Most Restrictive Indication .... 9-3
- 9.8 Next Governing Signal ..... 9-3
- 9.9 Train Delayed Within a Block ..... 9-3
  - 9.9.1 Approach to Automatic Interlocking .... 9-4
- 9.10 Initiating Movement Between Signals ..... 9-4
- 9.11 Movement from Signal Requiring Restricted Speed..... 9-4
- 9.12 Stop Indications..... 9-5
  - 9.12.1 CTC Territory ..... 9-5
  - 9.12.2 Manual Interlockings..... 9-5
  - 9.12.3 Automatic Interlockings..... 9-6
  - 9.12.4 ABS Territory..... 9-6
- 9.13 When Instructed to Operate Dual Control Switches by Hand ..... 9-6
  - 9.13.1 Hand Operation of Dual Control Switches ..... 9-7
- 9.14 Movement with the Current of Traffic ..... 9-7
  - 9.14.1 Reporting Clear of a Track Having a Current of Traffic..... 9-7
- 9.15 Track Permits ..... 9-8
  - 9.15.1 Issuing Track Permits ..... 9-8
  - 9.15.2 Clearing Track Permits ..... 9-8
- 9.16 Stop and Proceed Indication ..... 9-9
- 9.17 Entering Signaled Track at Hand-Operated or Spring Switch ..... 9-10
  - 9.17.1 Signal Protection in ABS by Lining Switch ..... 9-12
- 9.18 Electrically Locked Switches and Derails..... 9-12
- 9.19 Leaving Equipment in Signal Systems..... 9-13
- 9.20 Clear Track Circuits..... 9-13
- 9.21 Overlap Circuits..... 9-13



9.22	Standing on Sanded Rail .....	9-13			
9.23	Suspension of Block System.....	9-13			
	9.23.1 Guidelines While Block System is Suspended.....	9-14			
9.24	Call Lights .....	9-14			
<b>10.0</b>	<b>Rules Applicable Only in Centralized Traffic Control (CTC) .....</b>	<b>10-1</b>			
10.1	Authority to Enter CTC Limits.....	10-1			
10.2	Clearing Through Hand-Operated Switches .....	10-1			
	10.1.1 Leaving the Main Track.....	10-1			
10.3	Track and Time .....	10-3			
	10.3.1 Protection of Limits .....	10-4			
	10.3.2 Protection of Machines, Track Cars, or Employees.....	10-4			
	10.3.3 Joint Track and Time.....	10-4			
	10.3.4 Track and Time Acknowledgment.....	10-4			
<b>11.0</b>	<b>Rules Applicable in ACS, ATC and ATS Territories .....</b>	<b>11-1</b>			
11.1	Establishing Absolute Block .....	11-1			
11.2	Signal Indications with Absolute Block.....	11-1			
11.3	Broken or Missing Seals .....	11-1			
<b>12.0</b>	<b>Rules Applicable Only in Automatic Train Stop System (ATS) Territory .....</b>	<b>12-1</b>			
12.1	Required Equipment .....	12-1			
	12.1.1 ATS Seals and Keys .....	12-1			
12.2	ATS Device Cut Out, Not Equipped, or Not Working .....	12-1			
12.3	Unusual Conditions .....	12-1			
	12.3.1 ATS Penalty Brake Application .....	12-1			
	12.3.2 ATS Inoperative .....	12-1			
	12.3.3 Damaged Inductor .....	12-1			
12.4	ATS Testing .....	12-2			
	12.4.1 Test Inductor Locations.....	12-2			
	12.4.2 No Test Inductors.....	12-2			
<b>13.0</b>	<b>Rules Applicable Only in Automatic Cab Signal System (ACS) Territory.....</b>	<b>13-1</b>			
13.1	General Information .....	13-1			
	13.1.1 Observance of Signals.....	13-1			
	13.1.2 Conforming with Block Signals .....	13-1			
	13.1.3 Does Not Indicate Conditions Ahead... ..	13-1			
	13.1.4 Cab Signals Cut In and Out.....	13-2			
13.2	Normal Operation.....	13-2			
	13.2.1 Restrictive to More Favorable.....	13-2			
	13.2.2 Favorable to More Restrictive.....	13-3			
	13.2.3 Elimination of Audible Indicator.....	13-3			
13.3	Unusual Conditions .....	13-4			
	13.3.1 Cab Signal and Block Signal Do Not Agree .....	13-4			
	13.3.2 Inoperative Cab Signal Device .....	13-4			
	13.3.3 Movement with an Inoperative Cab Signal Device.....	13-4			
<b>14.0</b>	<b>Rules Applicable Only Within Track Warrant Control (TWC) Limits .....</b>	<b>14-1</b>			
14.1	Authority to Enter TWC Limits.....	14-1			
14.2	Designated Limits.....	14-2			
14.3	Operating with Track Warrants.....	14-2			
	14.3.1 Leaving the Main Track.....	14-3			
14.4	Occupying Same Track Warrant Limits .....	14-3			
	14.4.1 Radio Blocking.....	14-4			
14.5	Protecting Men or Equipment.....	14-5			
14.6	Movement Against the Current of Traffic.....	14-5			
14.7	Reporting Clear of Limits.....	14-5			
14.8	Track Warrant Requests .....	14-6			
14.9	Copying Track Warrants.....	14-6			
	14.9.1 Duplicating Track Warrants.....	14-7			
14.10	Track Warrant in Effect.....	14-7			
14.11	Changing Track Warrants .....	14-8			
14.12	Not Used .....	14-8			
14.13	Mechanical Transmission of Track Warrants .....	14-8			
<b>15.0</b>	<b>Track Bulletin Rules .....</b>	<b>15-1</b>			
15.1	Track Bulletins.....	15-2			
	15.1.1 Changing Address of Track Warrants or Track Bulletins .....	15-2			
15.2	Protection by Track Bulletin Form B.....	15-2			
	15.2.1 Protection for On-Track Equipment .....	15-3			
15.3	Authorizing Movement Against the Current of Traffic .....	15-3			
15.4	Protection When Tracks Removed from Service	15-4			
15.5	Protection When Tracks Blocked with Equipment.....	15-4			
15.6	Change of a General Order, Special Instruction, or Rule .....	15-5			
15.7	Copying Track Bulletins.....	15-5			
15.8	Duplicating Track Bulletins .....	15-5			
15.9	Mechanical Transmission of Track Bulletins .....	15-5			
15.10	Retaining Track Bulletins.....	15-5			
15.11	Not Used .....	15-5			
	15.13.1 Voiding General Track Bulletins or Restrictions.....	15-6			
15.12	Relief of Engineer or Conductor During Trip .....	15-6			
15.13	Voiding Track Bulletins.....	15-6			
15.14	Delivering Track Bulletins.....	15-6			
<b>16.0</b>	<b>Rules Applicable Only in Direct Traffic Control (DTC) Limits .....</b>	<b>16-1</b>			
16.1	Authority to Enter DTC Limits.....	16-1			
	16.1.1 Switches Between DTC Blocks .....	16-1			
16.2	DTC Authority.....	16-1			
16.3	Movement in a Specified Direction.....	16-2			

16.3.1	Leaving the Main Track.....	16-3
16.4	Work and Time .....	16-3
16.5	Changing DTC Authority .....	16-4
16.6	Releasing DTC Authority.....	16-4
16.7	Communication Failure .....	16-5
<b>17.0</b>	<b>Rules Applicable Only in Automatic Train Control (ATC) Territory .....</b>	<b>17-1</b>
17.1	Automatic Train Control Territory.....	17-1
17.2	Taking Charge.....	17-1
17.3	Cut In and Cut Out Requirements.....	17-1
17.4	Departure Test Requirements .....	17-2
17.4.1	Departure Test Reporting.....	17-3
17.5	High Speed Setting .....	17-3
17.5.1	Over 40 MPH.....	17-3
17.5.2	Under 40 MPH.....	17-3
17.5.3	Restricting Cab Signal .....	17-4
17.6	Conforming with Block Signals.....	17-4
17.6.1	Approaching Diverging Route.....	17-4
17.7	ATC Failure/Cut Out Enroute .....	17-4
17.7.1	Speed Indicator in ATC.....	17-5
17.7.2	ATC Motion Light .....	17-5
17.7.3	Audible Indicator.....	17-5
17.8	Improper Display.....	17-5
<b>18.0</b>	<b>Section Reserved .....</b>	<b>17-6</b>
<b>19.0</b>	<b>Section Reserved .....</b>	<b>17-6</b>
<b>20.0</b>	<b>Occupancy Control System (OCS) .....</b>	<b>20-1</b>
20.1	OCS for Trains and Engines .....	20-1
<b>Glossary</b>	.....	<b>GL-2</b>
<b>Index</b>	.....	<b>IN-1</b>

## **1.0 General Responsibilities**

### **1.1 Safety**

Safety is the most important element in performing duties. Obeying the rules is essential to job safety and continued employment.

#### **1.1.1 Maintaining a Safe Course**

In case of doubt or uncertainty, take the safe course.

#### **1.1.2 Alert and Attentive**

Employees must be careful to prevent injuring themselves or others. They must be alert and attentive when performing their duties and plan their work to avoid injury.

#### **1.1.3 Accidents, Injuries, and Defects**

Report by the first means of communication any accidents; personal injuries; defects in tracks, bridges, or signals; or any unusual condition that may affect the safe and efficient operation of the railroad. Where required, furnish a written report promptly after reporting the incident.

#### **1.1.4 Condition of Equipment and Tools**

Employees must check the condition of equipment and tools they use to perform their duties. Employees must not use defective equipment or tools until they are safe to use. Employees must report any defects to the proper authority.

### **1.2 Personal Injuries and Accidents**

#### **1.2.1 Care for Injured**

When passengers or employees are injured, do everything reasonable to care for them.

#### **1.2.2 Witnesses**

If equipment is involved in personal injury, loss of life, or damage to property, the employee in charge must immediately secure the names, addresses, and occupations of all persons involved, including all persons at the scene when the accident occurred and those that arrived soon after. The employee in charge must secure the names regardless of whether these persons admit knowing anything about the accident.

The employee in charge must also obtain the license numbers of nearby automobiles. When necessary, other employees can assist in obtaining this information, which must be included in reports covering the incident.

Where signaling devices are provided or a flagman is on duty, the employee in charge and assisting employees must try to determine who, among the witnesses, can testify whether the signaling devices were functioning properly or if the flagman was performing his duties properly.

When possible, obtain the names of witnesses who can testify about the bell and whistle signals.

### **1.2.3 Equipment Inspection**

If an accident results in personal injury or death, all tools, machinery, and other equipment involved, including the accident site, must be inspected promptly by the foreman, another person in charge of the work, or other competent inspectors. The inspector must promptly forward to his manager a report of the inspection. The report must include the condition of the equipment and the names of those making the inspection.

The equipment inspected must be marked for identification and placed in custody of the responsible manager or employee until the claims department is contacted and determines disposition.

### **1.2.4 Mechanical Inspection**

When engines, cars, or other equipment are involved in an accident that results in personal injury or death, the equipment must be inspected before it leaves the accident site.

A mechanical department employee must further inspect the equipment at the first terminal. This employee must promptly report inspection results to the proper manager.

### **1.2.5 Reporting**

All cases of personal injury, while on duty or on company property, must be immediately reported to the proper manager and the prescribed form completed.

A personal injury that occurs while off duty that will in any way affect employee performance of duties must be reported to the proper manager as soon as possible. The injured employee must also complete the prescribed written form before returning to service.

If an employee receives a medical diagnosis of occupational illness, the employee must report it immediately to the proper manager.

### **1.2.6 Statements**

Except when authorized by the proper manager:

- Information concerning accidents or personal injuries that occur to persons other than employees may be given only to an authorized representative of the railroad or an officer of the law.
- Information about the facts concerning the injury or death of an employee may be given only to a person in interest such as the injured employee, an immediate relative of the injured or deceased employee, an authorized representative of the railroad, or an officer of the law.
- Information in the files or in other privileged or confidential reports of the railroad concerning accidents or personal injuries may be given only to an authorized representative of the railroad.

### **1.2.7 Furnishing Information**

Employees must not withhold information, or fail to give all the facts to those authorized to receive information regarding unusual events, accidents, personal injuries, or rule violations.

## 1.3 Rules

### 1.3.1 Rules, Regulations, and Instructions

**Safety Rules.** Employees must have a copy of, be familiar with, and comply with all safety rules issued in a separate book or in another form.

**General Code of Operating Rules.** Employees governed by these rules must have a current copy they can refer to while on duty.

**Hazardous Materials.** Employees who in any way handle hazardous materials must have a copy of the instructions or regulations for handling these materials. Employees must be familiar with and comply with these instructions or regulations.

**Air Brakes.** Employees whose duties are affected by air brake operation must have a copy of the rules and instructions for operating air brakes and train handling. Employees must know and obey these rules and instructions.

**Timetable and Special Instructions.** Employees whose duties are affected by the timetable and special instructions must have a current copy they can refer to while on duty.

**Train Dispatchers and Control Operators.** The train dispatchers and control operators must have a copy of the rules and instructions for train dispatchers and control operators. They must be familiar with and obey those rules and instructions.

**Classes.** Employees must be familiar with and obey all rules, regulations, and instructions and must attend required classes. They must pass the required examinations.

**Explanation.** Employees must ask their supervisor for an explanation of any rule, regulation, or instruction they are unsure of.

**Issued, Canceled, or Modified.** Rules may be issued, canceled, or modified by track bulletin, general order, or special instructions.

### 1.3.2 General Orders

General orders:

- Are numbered consecutively.
- Are issued and canceled by the designated manager.
- Contain only information and instructions related to rules or operating practices.
- Replace any rule, special instruction, or regulation that conflicts with the general order.

Before beginning each day's work or trip, crew members and any others whose duties require, must review general orders that apply to the territory they will work on.

### 1.3.3 Circulars, Instructions, and Notices

Circulars, instructions, notices, and other information are issued and canceled by the designated manager. Before beginning each day's work or trip, crew members and any others whose duties require, must review those that apply to the territory they will work on.

## 1.4 Carrying Out Rules and Reporting Violations

Employees must cooperate and assist in carrying out the rules and instructions. They must promptly report any violations to the proper supervisor. They must also report any condition or practice that may threaten the safety of trains, passengers, or employees, and any misconduct or negligence that may affect the interest of the railroad.

### 1.4.1 Good Faith Challenge

#### A. Right to Challenge

Federal Regulations have provisions that allow an employee the right to challenge a directive which, based upon the employee's good faith determination, would violate a railroad operating rule relating to:

- Shoving movements.
  - Leaving equipment foul of an adjacent track.
- or
- Handling of hand-operated switches or fixed derails.

#### B. Good Faith Challenge Procedure

1. An employee may inform a supervisor issuing a directive that a good faith determination has been made that the directive would violate a railroad operating rule relating to:
  - Shoving movements.
  - Leaving equipment foul of an adjacent track.

or

  - Handling of hand-operated switches or fixed derails.
2. The supervisor will not require the employee to comply with the directive until the challenge is resolved. The supervisor may:
  - Require the challenging employee to perform other tasks not related to the challenge until the challenge is resolved.

or

  - Direct an employee, other than the challenging employee, to perform the challenged task before the challenge is resolved. Employee so directed will be informed of the challenge, and determine that the challenged task does not violate the rules.

#### C. Resolving Good Faith Challenge

1. A challenge may be resolved by one of the following:
  - The supervisor's acceptance of the employee's request.
  - An employee's acceptance of the directive.
  - An employee's agreement to a compromise solution acceptable to the person issuing the directive.
2. If the challenge cannot be resolved because the supervisor issuing the directive has determined that the employee's challenge has not been made in good faith or there is no alternative to the direct order, the railroad will:
  - Provide immediate review by at least one manager, which must not be conducted by the supervisor issuing the challenged directive or that supervisor's subordinate.
  - Resolve the challenge using the same options available for resolving the challenge as the initial supervisor.

3. If the manager making the final decision concludes that the challenged directive would not cause the employee to violate any requirement of the involved rules, the reviewing manager's decision shall be final and not subject to further immediate review.
  - The manager will inform the employee that Federal law may protect the employee from retaliation, if the employee's refusal to do the work is a lawful, good faith act.
  - The employee making the challenge will be afforded an opportunity to document, in writing or electronically, any protest to the manager making the final decision before the employee's tour of duty is complete. The employee will be afforded the opportunity to retain a copy of the protest.

#### **D. Request for Review and Verification of Decision**

Upon written request, at the time of the challenge, the employee has the right for further review by the "Designated Review Manager". Within 30 days after the expiration of the month during which the challenge occurred, the "Designated Review Manager" will verify the proper application of the rule in question. The verification decision shall be made in writing to the employee.

#### **E. Employee Rights and Remedies**

The Good Faith Challenge is not intended to abridge any rights or remedies available to the employee under a collective bargaining agreement or any Federal law.

## **1.5 Drugs and Alcohol**

The use or possession of alcoholic beverages while on duty or on company property is prohibited. Employees must not have any measurable alcohol in their breath or in their bodily fluids when reporting for duty, while on duty, or while on company property.

The use or possession of intoxicants, over-the-counter or prescription drugs, narcotics, controlled substances, or medication that may adversely affect safe performance is prohibited while on duty or on company property, except medication that is permitted by a medical practitioner and used as prescribed. Employees must not have any prohibited substances in their bodily fluids when reporting for duty, while on duty, or while on company property.

## **1.6 Conduct**

Employees must not be:

1. Careless of the safety of themselves or others.
  2. Negligent.
  3. Insubordinate.
  4. Dishonest.
  5. Immoral.
  6. Quarrelsome.
- or
7. Discourteous.

Any act of hostility, misconduct, or willful disregard or negligence affecting the interest of the company or its employees is cause for dismissal and must be reported. Indifference to duty or to the performance of duty will not be tolerated.

### 1.6.1 Motor Vehicle Driving Records

Employees certified as engineers, whatever class of service, must report convictions for:

- Operating a motor vehicle while under the influence of, or impaired by, alcohol or a controlled substance.
- Refusal to undergo such testing when a law enforcement official seeks to find out whether a person is operating under the influence of alcohol or a controlled substance.

State-sponsored diversion programs, guilty pleas, and completed state actions to cancel, revoke, suspend, or deny a driver's license are considered convictions as applied to this rule.

An employee must report any conviction to an employee assistance representative within 48 hours after the employee receives notice of the conviction.

### 1.6.2 Notification of Felony Convictions

The conduct of any employee leading to conviction of any felony is prohibited. Any employee convicted of a felony must notify the proper authority of that fact within 48 hours after the employee receives notice of the conviction.

### 1.6.3 Notification of Deteriorating Vision or Hearing

Any engineer who has knowledge that their hearing or vision has deteriorated and cannot be corrected to the minimum acceptable requirement as outlined in federal regulations (20/40 distant visual acuity, 70 degree field of vision, ability to recognize/distinguish between railroad color signals, hearing loss no greater than 40 decibels) must report that fact immediately to the proper authority or the medical department.

## 1.7 Altercations

Employees must not enter into altercations with each other, play practical jokes, or wrestle while on duty or on railroad property.

## 1.8 Appearance

Employees reporting for duty must be clean and neat. They must wear the prescribed uniform when required.

## 1.9 Respect of Railroad Company

Employees must behave in such a way that the railroad will not be criticized for their actions.

## 1.10 Games, Reading, or Electronic Devices

### **BNSF Amendment—Entire rule is changed to read:**

Employees on duty must not:

- Play games.
- Read magazines, newspapers, or other literature not related to their duties.
- Have magazines, newspapers, and other literature not related to duties available for viewing in the cab of engines. This does not prohibit employees from having such material enclosed in their personal luggage.



**Cellular Phones**

During normal operations, cellular phones must be turned off and ear pieces removed:

- When employees are on a moving train (includes supervisors).
- When members of your crew are on the ground performing duties related to train movement, switching, performing air tests, riding equipment, providing inspection of passing trains, assisting in preparation of their train or fouling the track (within four feet of nearest rail of a track).
- When other employees are performing safety related duties associated with your train.

**Exceptions: Cellular phones may be used:**

- For voice communications only, while train is stopped and any member of their crew is not engaged in safety-related duties including switching, performing air tests, riding equipment, inspecting passing trains, assisting in preparation of a train or fouling the track (within four feet of nearest rail of track), and all crew members have been briefed that operations have been suspended.
- To access electronically stored rule-related files (only) when train is stopped. However, text messaging, e-mailing or use of other device features is prohibited.
- While on passenger trains or business cars for business purposes provided they are not used in the controlling unit or the cab room of the controlling cab car. Use must not interfere with any safety related duties including calling or acknowledging signals.
- When use relates to mechanical or technical evaluations (e.g. testing of signal system, Electronic Train Management System, distributed power, etc.). Before using the cell phone, a safety briefing is required with all assigned crew members and all must agree how communications can safely take place.
- During emergencies, while deadheading or transporting by means other than on a freight train, or as outlined in GCOR 2.5 (Communication Redundancy) due to radio failure.

**Electronic Devices**

Electronic devices such as Hammerhead, Renegade or other similar devices may be used for company business while train is stopped and no crew members are engaged in safety-related duties including switching, performing air tests, riding equipment, inspecting passing trains, assisting in preparation of a train or fouling the track (within four feet of nearest rail of a track) and all crew members have briefed that operations have been suspended.

Laptop computers may be used (only to access electronically stored rule-related files) when the train is stopped or while deadheading or being transported by means other than by freight train (without restriction).

Electronic devices such as DVD/CD players, MP3 players, iPods, internet browsers, text messaging and e-mailing devices:

- May not be used by crews on a train while on duty. Devices must be turned off and ear pieces removed (includes supervisors).
- May be used while deadheading or being transported by means other than by freight train.

Railroad supplied devices related to train movement and locomotive/train control systems (e.g. Remote Control Transmitter, railroad electronic displays, Electronic Train Management System, distributed power, head-end device, etc.) are not restricted or prohibited.

Digital clocks/timepieces are not considered electronic devices.

## 1.11 Sleeping

Employees must not sleep while on duty, except as outlined under Rule 1.11.1 (Napping). Employees reclined with their eyes closed will be in violation of this rule.

### 1.11.1 Napping

Napping is permitted by train crews, except crews in passenger, commuter or yard service, under the following conditions:

- The crew is waiting for departure of their train.
- or
- The train is stopped enroute waiting to be met or passed by a train, waiting for track work, waiting for helper locomotive, or similar conditions.

Restrictions are as follows:

- A job briefing must be conducted, with agreement reached as to who will nap and who must remain awake. Each crew member has the right and responsibility to refuse to allow another crew member to take a nap if doing so could jeopardize the personal safety of employees, the train, or the public.
- One crew member must remain awake at all times.
- The nap period must not exceed 45 minutes, which includes the time needed to fall asleep. The napping employee is relieved of all duties.
- Train must not be delayed for an employee to take a nap. When conditions allow the train to move, the employee who is to remain awake must immediately waken the napping employee.
- Before napping, while waiting for the arrival of their train, employees must ensure all duties have been completed. These duties include reviewing general orders and notices; securing and reviewing track warrants, track bulletins, and other paperwork, if available.
- Before napping is allowed enroute, the employee in charge of the locomotive controls must:
  1. Make at least a 10-lb. brake pipe reduction.
  2. Place generator field switch in the "OFF" position.
  3. Center the reverser and remove, if removable.
- The employee who is to remain awake must remain on the locomotive while others on the locomotive are napping, except when inspecting passing trains.
- If waiting for the arrival of or make-up of train, one crew member must remain awake while waiting for their train's arrival or make-up at their initial terminal unless arrangements have been made with a third party to wake up all crew members.

All crew members that are deadheading or otherwise relieved of duties may nap.

## 1.12 Weapons

While on duty or on railroad property, employees must not have firearms or other deadly weapons, including knives with a blade longer than 3 inches. However, railroad police are authorized to possess firearms in the course of their work.

### **1.13 Reporting and Complying with Instructions**

Employees will report to and comply with instructions from supervisors who have the proper jurisdiction. Employees will comply with instructions issued by managers of various departments when the instructions apply to their duties.

### **1.14 Employee Jurisdiction**

Employees are under the jurisdiction of the supervisors of the railroad they are operating on.

When operating on another railroad, unless otherwise instructed, employees will be governed by:

- Safety rules, air brake and train handling rules, and hazardous materials instructions of the railroad they are employed by.
- The operating rules, timetable and special instructions of the railroad they are operating on.

### **1.15 Duty - Reporting or Absence**

Employees must report for duty at the designated time and place with the necessary equipment to perform their duties. They must spend their time on duty working only for the railroad. Employees must not leave their assignment, exchange duties, or allow others to fill their assignment without proper authority. Continued failure by employees to protect their employment will be cause for dismissal.

### **1.16 Subject to Call**

Employees subject to call must indicate where they can be reached and must not be absent from their calling place without notifying those required to call them.

### **1.17 Hours of Service Law**

Employees must be familiar and comply with the requirements of the federal hours of service law. Employees are expected to use off-duty time so they are prepared for work.

If an employee is called to report for duty before legal off-duty time has expired, before accepting the call to work, the employee must notify the individual making the call that off-duty time has not expired.

#### **A. Notification**

When communication is available, employees must notify the train dispatcher or another authority of the time the law requires them to be off duty. Employees must provide notification early enough that they may be relieved, or transportation provided, before they exceed the hours of service.

#### **B. Exceeding the Law**

Employees must not exceed the hours of service law without proper authority. However, they must not leave trains, engines, or cars on the main track without proper protection. Employees must secure trains properly and, if possible, before they exceed the hours of service. Except as provided by this paragraph, employees are then relieved of all duties.

### **1.18 Unauthorized Employment**

Employees must not engage in another business or occupation that would create a conflict of interest with their employment on the railroad or would interfere with their availability for service or the proper performance of their duties.

### **1.19 Care of Property**

Employees are responsible for properly using and caring for railroad property. Employees must return the property when the proper authority requests them to do so. Employees must not use railroad property for their personal use.

### **1.20 Alert to Train Movement**

Employees must expect the movement of trains, engines, cars, or other movable equipment at any time, on any track, and in either direction.

Employees must not stand on the track in front of an approaching engine, car, or other moving equipment.

Employees must be aware of location of structures or obstructions where clearances are close.

### **1.21 Occupying Roof**

Employees whose duties require them to occupy the roof of a car or engine must do so only with proper authority and when the equipment is standing.

### **1.22 Not Permitted on Equipment**

Unauthorized persons must not be permitted on equipment.

### **1.23 Altering Equipment**

Without proper authority, employees must not alter, nullify, change the design of, or in any manner restrict or interfere with the normal function of any device or equipment on engines, cars, or other railroad property, except in the case of an emergency. Employees must report to the proper supervisor changes made in an emergency.

### **1.24 Clean Property**

Railroad property must be kept in a clean, orderly, and safe condition. Railroad buildings, facilities, or equipment must not be damaged or defaced. Only information authorized by the proper manager or required by law may be posted on railroad property.

### **1.25 Credit or Property**

Unless specifically authorized, employees must not use the railroad's credit and must not receive or pay out money on the railroad account. Employees must not sell or in any way get rid of railroad property without proper authority. Employees must care for all articles of value found on railroad property and promptly report the articles to the proper authority.

### **1.26 Gratuities**

Employees must not discriminate among railroad customers. Employees must not accept gifts or rewards from customers, suppliers, or contractors of the railroad unless authorized by the proper manager.

## 1.27 Divulging Information

Employees who make up, handle, or care for any of the following must not allow an unauthorized person to access them or disclose any information contained in them:

- Correspondence.
- Reports.
- Books.
- Bills of Lading.
- Waybills.
- Tickets.
- Statistics.

## 1.28 Fire

Employees must take every precaution to prevent loss and damage by fire.

Employees must report promptly to the train dispatcher any fires seen on or near the right of way, unless the fires are being controlled. If there is danger of the fire spreading to a bridge or other structure, crew members must stop their train and help extinguish the fire.

Cause of fire, if known, must be promptly reported.

## 1.29 Avoiding Delays

Crew members must operate trains and engines safely and efficiently. All employees must avoid unnecessary delays.

When possible, train or engine crews wanting to stop the train to eat must ask the train dispatcher at least one hour and thirty minutes before the desired stop.

## 1.30 Riding Engine

When possible, crew members on the head end of freight trains must ride in the control compartment of the engine.

When riding on the head end, the conductor will ride in the control compartment.

## 1.31 Repairs to Foreign Cars

Crew members who repair foreign cars must report the repairs on the prescribed form.

## 1.32 Overheated Wheels

When overheated wheels are found on a train, the train must be stopped and held a minimum of 10 minutes to allow the heat to equalize through the wheel.

### 1.33 Inspection of Freight Cars

When personnel are not on duty primarily to inspect freight cars, each car placed in the train may be moved after it receives a safety inspection as follows:

- Cars must be checked for:
  - Leaning.
  - Sagging.
  - Improper position on the truck.
  - Objects hanging or dragging from the car or extending from the side.
  - Insecurely attached doors.
  - Broken or missing safety appliances.
  - Contents leaking from placarded hazardous material car.
  - Insecure coupling device.
  - Overheated wheel or journal.
  - Broken or cracked wheel.
  - Brake that fails to release.
  - Staff type brake not in fully raised position.
  - Any apparent hazard that could cause an accident.
- Open top loads, including trailers and containers on flat cars, must be loaded safely.
- If width or height approaches clearance restrictions, movement must be cleared with the proper authority.

A freight car with any defect that makes movement unsafe must be corrected or set out of the train. When a defect is discovered enroute, note the type of defect on proper tag and attach a tag on each side of the car.

A freight car with three bad order tags indicating that the car is safe to move may be moved to the nearest car repair point. The conductor will remove one bad order tag from the side with two tags. The conductor will use this written information from the tag to inform other crew members of the restrictions.

### 1.34 Flat Spots

If a wheel on a piece of equipment has a flat spot more than 2 1/2 inches long, or if the wheel has adjoining flat spots that are each at least 2 inches long, the equipment must not be moved faster than 10 MPH. Such equipment must be set out at the first available point.

### 1.35 Dump Doors

Be sure dump doors on cars are closed after a load is dumped. If car must be moved short distances with the dump doors open, make sure the doors and chains will clear tracks and crossings.

### 1.36 Excessive Dimension Loads

Place excessive dimension loads on or near the head end of trains.

Instructions will be issued to trains handling excessive dimension loads. If no instructions have been issued regarding handling the car, the conductor will immediately notify the train dispatcher.

Crew members handling excessive dimension equipment must ensure that the equipment will clear nearby objects, including equipment on adjacent tracks. If the train cannot reach a point with enough clearance, crew members must make sure protection is provided against movements on adjacent tracks.

### 1.37 Open Top Loads

**BNSF Amendment—Entire rule is changed to read:**

Flat cars, open top cars, and open TOFC/COFC's with loads which protrude beyond the car ends or if shifted, would protrude beyond the car ends must not be placed in trains next to the following if train length and makeup permit:

- Occupied outfit car
- Passenger car
- Engine
- Caboose
- Shipment of automotive vehicles or machinery that is not fully enclosed

This restriction does not apply to cars equipped with chains or cables securing the load to the car.

### 1.38 Shipments Susceptible to Damage

Shipments with painted or finished surfaces susceptible to damage, such as automobiles, trucks, tractors, combines, and other similar equipment or machinery, must not be placed closer than the fifth car behind open top cars loaded with commodities such as coal, sand, gravel, lime, soda ash, etc. subject to wind, vapor, or fume action on adjacent cars. Exceptions include shipments susceptible to damage that are:

- Loaded in cars that fully enclose the shipments.
- or
- Fully protected by a covering.

An open top car loaded with sand, gravel, lime, soda ash, etc. subject to wind, vapor, or fume action in other than a solid unit train must not be placed immediately ahead of an occupied caboose.

### 1.39 Accuracy of Speed Indicator

The engineer must verify speed indicator accuracy as soon as possible after taking charge of the engine. If the speed indicator is not accurate to within 3 MPH plus or minus at speeds of 10 to 30 MPH and to within 5 MPH plus or minus at speeds above 30 MPH, the engineer must immediately report the variance to the train dispatcher.

### 1.40 Reporting Engine Defects

The engineer will report any engine defect on the proper form and notify the relieving engineer, when needed.

## 1.41 Engines Coupled to Occupied Passenger Cars

Engines coupled to equipment that includes occupied passenger cars must not be left without an authorized employee in charge.

## 1.42 Trains Detoured

When trains are detoured over another railroad, the engineer of the detoured train will operate the engine, unless otherwise approved by a manager of the railroad the train is being detoured over.

The pilot will inform the engineer of speed restrictions, signals, sidings, etc. to make sure the train detours over the railroad safely.

## 1.43 Stopped in Tunnels

### A. Engine or Train Stopped in Tunnel

When an engine is stopped in a tunnel and cannot move promptly, crew members must:

1. Shut down diesel engine at once.
2. Shut down Waukesha or similar type engines.
3. Make a full service air brake application.
4. Apply hand brakes to prevent movement in case the air brakes leak off.

### B. Passenger Train Stopped in Tunnel or Deep Snow

Crew members of a passenger train stopped in a tunnel or deep snow must:

1. Shut off any air circulating systems including:
  - a. Air conditioning.
  - b. Ice machines.
  - c. Generators.
2. Shut air intake shutters.
3. Turn off blower fans.

### C. Notification if Stopped in Tunnel or Deep Snow

The train dispatcher should be notified immediately so that proper arrangements can be made to protect persons and equipment.

### D. When These Requirements Will Not Apply

These requirements will not apply if air currents carry the exhaust gases away from the train. Safety of passengers and crew members must be the first consideration.

## 1.44 Duties of Train Dispatchers

Train dispatchers supervise train movement and any employees connected with that movement.

## 1.45 Duties of Control Operators and Operators

Control operators and operators are under the direction of the train dispatcher when their duties concern handling track warrants, track bulletins, lineups, the movement of trains, and any other instructions issued by the train dispatcher.



## 1.46 Duties of Yardmasters

The yardmaster is responsible for and shall directly supervise yard crews, clerks, and all other employees working in the yard. The yardmaster must see that they work in a safe, efficient, and economical manner, according to the rules, regulations, and instructions of the railroad. Yardmasters must ensure the prompt and regular movement of cars, especially the proper makeup of trains and their movement into and out of the yard.

At locations where yardmasters are on duty, employees in train, engine, and yard service must comply with the yardmaster's instructions. At locations where no yardmaster is on duty, these employees will work according to the instructions of designated employees.

**BNSF Amendment—The following is added:**

At the end of each shift, the yardmaster must make a transfer, filling in all the required information, including:

- All grade crossings out of service
- Any undelivered Track Bulletin Restrictions
- Any tracks, switches, or other infrastructure out of service
- Any other conditions or issues which may affect the safe and efficient management of the yard.

If the office has more than one shift, the yardmaster being relieved will remain until the relieving yardmaster understands, accepts, and acknowledges the transfer.

The transfer must be documented in Yardmaster Transfer in YDS. If TSS is not available, the transfer must be documented in writing and maintained for 30 days.

## 1.47 Duties of Crew Members

The conductor and the engineer are responsible for the safety and protection of their train and observance of the rules. They must ensure that their subordinates are familiar with their duties, determine the extent of their experience and knowledge of the rules. They must instruct them, when necessary, how to perform their work properly and safely. If any conditions are not covered by the rules, they must take precautions to provide protection.

### A. Conductor Responsibilities

1. The conductor supervises the operation and administration of the train (if trains are combined with more than one conductor on board, the conductor with the most seniority takes charge). All persons employed on the train must obey the conductor's instructions, unless the instructions endanger the train's safety or violate the rules. If any doubts arise concerning the authority for proceeding or safety, the conductor must consult with the engineer who will be equally responsible for the safety and proper handling of the train.
2. The conductor must advise the engineer and train dispatcher of any restriction placed on equipment being handled.
3. The conductor must remind the engineer that the train is approaching an area restricted by:
  - Limits of authority.
  - Track warrant.
  - Track bulletin.

or

  - Radio speed restriction.

The conductor must inform the engineer after the train passes the last station, but at least 2 miles from the restriction.

4. When the conductor is not present, other crew members must obey the instructions of the engineer concerning rules, safety, and protection of the train.
5. Freight conductors are responsible for the freight carried by their train. They are also responsible for ensuring that the freight is delivered with any accompanying documents to its destination or terminals. Freight conductors must maintain any required records.

#### **B. Engineer Responsibilities**

1. The engineer is responsible for safely and efficiently operating the engine. Crew members must obey the engineer's instructions that concern operating the engine. A student engineer or other qualified employee may operate the engine under close supervision of the engineer. Any employee that operates an engine must have a current certificate in their possession.
2. The engineer must check with the conductor to determine if any cars or units in the train require special handling.

#### **C. All Crew Members' Responsibilities**

1. To ensure the train is operated safely and rules are observed, all crew members must act responsibly to prevent accidents or rule violations. Crew members in the engine control compartment must communicate to each other any restrictions or other known conditions that affect the safe operation of their train sufficiently in advance of such condition to allow the engineer to take proper action. If proper action is not being taken, crew members must remind engineer of such condition and required action.
2. Crew members in the engine control compartment must be alert for signals. As soon as signals become visible or audible, crew members must communicate clearly to each other the name of signals affecting their train. They must continue to observe signals and announce any change of aspect until the train passes the signal. If the signal is not complied with promptly, crew members must remind the engineer and/or conductor of the rule requirement. If crew members do not agree on the signal indication, regard the signal as the most restrictive indication observed.

**BNSF Amendment—The following is added:**

Crew members must not use binoculars or similar devices to determine the position, aspect, or indication displayed by a fixed signal.

3. When the engineer and/or conductor fail to comply with a signal indication or take proper action to comply with a restriction or rule, crew members must immediately take action to ensure safety, using the emergency brake valve to stop the train, if necessary.

## **1.48 Time**

While on duty, crew members must have a watch. Other employees must have access to a watch or clock.

The watch or clock must:

- Be in good working condition and reliable.
- Display hours, minutes, and seconds.
- Not vary from the correct time by more than 30 seconds.
- Be compared with the time source designated in special instructions.

## 2.0 Railroad Radio Rules

### 2.1 Transmitting

Any employee operating a radio must do the following:

- Before transmitting, listen long enough to make sure the channel is not being used.
- Give the required identification.
- Not proceed with further transmission until acknowledgment is received.

### 2.2 Required Identification

Employees transmitting or acknowledging a radio communication must begin with the required identification.

The identification must include the following in this order:

- For base or wayside stations:
  - Name or initials of the railroad.
  - Name and location or other unique designation.
- For mobile units:
  - Name or initials of the railroad.
  - Train name (number), engine number, or words that identify the precise mobile unit.

If communication continues without interruption, repeat the identification every 15 minutes.

#### Short Identification

After making a positive identification for switching, classification, and similar operations within a yard, fixed and mobile units may use a short identification after the initial transmission and acknowledgment.

### 2.3 Repetition

An employee who receives a transmission must repeat it to the person transmitting the message, except when the communication:

- Concerns yard switching operations.
  - Is a recorded message from an automatic alarm device.
- or
- Is general and does not contain any information, instruction, or advice that could affect the safety of a railroad operation.

### 2.4 Ending Transmissions

Employees using a radio for transmissions must state to the employee receiving the transmission the following as it applies to indicate the communication has ended or is completed:

“OVER” — when a response is expected.

or

“OUT” preceded by required identification — when no response is expected.

However, these requirements do not apply to yard switching operations.

## 2.5 Communication Redundancy

The controlling unit on any train that requires an air brake test must be equipped with an operative radio, unless relieved by Rule 2.18 (Malfunctioning Radio). In addition, trains must have a second means of communication, which may include:

- An operative radio on any unit in the consist.
- A portable radio.  
or
- Other wireless communication device.

## 2.6 Communication Not Understood or Incomplete

An employee who does not understand a radio communication or who receives a communication that is incomplete must not act upon the communication and must treat it as if it was not sent.

**EXCEPTION: An employee who receives information that may affect the safety of employees or the public or cause damage to property must take the safe course. When necessary, stop movement until the communication is understood.**

## 2.7 Monitoring Radio Transmissions

Radios in attended base stations or mobile units must be turned on to the appropriate channel with the volume loud enough to receive communications. Employees attending base stations or mobile units must acknowledge all transmissions directed to the station or unit.

## 2.8 Acknowledgment

An employee receiving a radio call must acknowledge the call immediately, unless doing so would interfere with safety.

## 2.9 Misuse of Radio Communications

**Employees must not use radio communication to avoid complying with any rule.**

## 2.10 Emergency Calls

Emergency calls will begin with the words “Emergency, Emergency, Emergency”. These calls will be used to cover initial reports of hazardous conditions which could result in death or injury, damage to property or serious disruption of railroad operations such as:

- Derailments.
- Collisions.
- Storms.
- Washouts.
- Fires.
- Track obstructions.  
or
- Emergency brake applications.

In addition, emergency calls must be made for the following:

- Overrunning limits of authority.
- or
- Overrunning Stop indications.

Emergency calls must contain as much complete information on the incident as possible.

All employees must give absolute priority to an emergency communication. Unless they are answering or aiding the emergency call, employees must not transmit until they are certain no interference will result.

## **2.11 Prohibited Transmissions**

Employees must not transmit a false emergency, or an unnecessary or unidentified communication. Employees must not use indecent language over the radio. Employees must not reveal the existence, contents, or meaning of any communication (except emergency communications) to persons other than those it is intended for or those whose duties may require knowing about it.

## **2.12 Fixed Signal Information**

Employees must not use the radio to give information to a train or engine crew about the name, position, aspect, or indication displayed by a fixed signal, unless the information is given between members of the same crew or the information is needed to warn of an emergency.

## **2.13 Not Used**

## **2.14 Transmission of Mandatory Directives**

When transmitted by radio, mandatory directives must conform to applicable operating rules and the following:

- The train dispatcher must state which mandatory directive will be transmitted.
- The employee must inform the train dispatcher when ready to copy stating the employee's occupation (ex. conductor, engineer, foreman, maintainer), name and location on the main track or where the main track will be entered. An employee operating the controls of a moving engine may not copy mandatory directives. In addition, mandatory directives must not be transmitted to the crew of a moving train if the conductor, engineer or train dispatcher feels that the transmission could adversely affect the safe operation of the train.
- The employee receiving a mandatory directive must copy it in writing using the format outlined in the operating rules.
- Before a mandatory directive is acted upon, the conductor and engineer must each have a written copy and each crew member must read and understand it.

### **2.14.1 Verbally Transmitting and Repeating Mandatory Directives**

When transmitting and repeating mandatory directives:

- State and spell single digit numbers by number and digit.
- State multiple digit numbers by number and digit.
- Identify decimal points as "point", "dot", or "decimal".
- State and spell directions.

**BNSF Amendment—The following rule is added:**

### **2.14.2 Before Reporting Clear of Authority Limits**

Before a field employee reports clear or releases a portion of authority limits, and the Train Dispatcher/Control Operator accepts the information, the following must occur:

- The employee will provide their name or other identification and the authority number to the Train Dispatcher/Control Operator.
- The Train Dispatcher/Control Operator will have the required form or computer screen displayed for data entry and confirmation.
- The Train Dispatcher/Control Operator and employee will carefully match the verbally transmitted information against the authority form to ensure the information matches and is correct.

## **2.15 Phonetic Alphabet**

If necessary, a phonetic alphabet (Alpha, Bravo, Charlie, etc.) will be used to pronounce clearly any letter used as an initial, except initial letters of railroads.

## **2.16 Assigned Frequencies**

The railroad must authorize any radio transmitters used in railroad service. Radio transmitters must operate on frequencies the Federal Communications Commission assigns the railroad. Employees are prohibited from using other transmitters or railroad frequencies not assigned to that particular territory.

## **2.17 Radio Testing**

Test radios to be used as soon as possible before beginning of work assignment.

The radio test must include an exchange of voice transmissions with another radio. The test must confirm the quality of the radio's transmission.

## **2.18 Malfunctioning Radio**

Malfunctioning radios must not be used. As soon as possible, notify each crew member and the train dispatcher or other affected employees that the radio is not working.

If a radio fails on the controlling locomotive enroute, the train may continue until the earlier of:

- The next calendar day inspection.
- or
- The nearest forward point where the radio can be repaired or replaced.

## **2.19 Blasting Operations**

Employees must not operate radio transmitters located less than 250 feet from blasting operations.

## **2.20 Internal Adjustments**

Employees are prohibited from making internal adjustments to a railroad radio unless they are specifically authorized by the FCC or hold a current Certified Technicians Certificate. Employees authorized to make adjustments must carry their FCC operator license, Certified Technicians Certificate, or verification card while on duty.

## 3.0 Section Reserved

**This page left blank intentionally.**



## **4.0 Timetables**

### **4.1 New Timetable**

The moment a new timetable goes into effect, it will replace the previous one.

#### **4.1.1 Notice of New Timetable**

At least 24 hours before a new timetable goes into effect, notification will be made by general order. A track bulletin will also be issued at least 24 hours before the new timetable goes into effect and continue for 6 days after the effective date.

### **4.2 Special Instructions**

Special instructions will replace any rule or regulation with which they conflict.

### **4.3 Timetable Characters**

Timetable characters are letters and symbols located in the timetable station column. These letters and symbols indicate the special conditions at specific locations (such as yard limits and manual interlockings). A timetable station column may also include information on the method of operation (such as TWC, ABS, CTC, or DTC). Explanation of characters will be shown in the timetable.

**This page left blank intentionally.**

## 5.0 Signals and Their Use

### 5.1 Signal Equipment

Employees who give or display signals must have the proper appliances. Appliances must be in good condition and ready to use.

### 5.2 Receiving and Giving Signals

#### 5.2.1 Looking for Signals

To recognize and follow signals correctly, employees must:

- Always be on the lookout for signals.
- Comply with the intent of the signal.
- Not act on any signal that they do not understand or that may be intended for other trains or engines.

#### 5.2.2 Signals Used by Employees

To give clear signals during the day and at night, employees must:

##### A. During the Day

1. Use the correct color of flags or lights.
2. Use day signals from sunrise to sunset.
3. Flagmen providing protection as outlined in Rule 6.19 (Flag Protection) must have a red flag and six red fusees.

##### B. At Night



1. Use the correct color of reflectorized flags or lights.
2. Use night signals from sunset to sunrise or when day signals cannot be seen clearly.
3. Flagmen providing protection as outlined in Rule 6.19 (Flag Protection) must have a white light and six red fusees.

Flags may be made from cloth, metal, or other suitable material.

## 5.3 Hand and Radio Signals

### 5.3.1 Hand Signals

The following diagram illustrates the hand signals for a train or engine to stop, proceed, or back up.

Description of Signal	Indication	Movement
1. Swung at a right angle to the track	STOP	
2. Raised and lowered vertically	PROCEED	
3. Swung slowly in a circle at a right angle to the track	BACK UP	

[Diagram A.]

Employees may use other hand signals only if all crew members understand the signals. When employees are not giving hand signals, they must not make any gestures or movements that may resemble a hand signal.

### 5.3.2 Giving Signals

Employees who give signals must:

- Make sure signals can be plainly seen.
- Give signals clearly so they can be understood.
- Give signals on the engineer's side of the track when practical.

### 5.3.3 Signal Disappearance

If a person disappears who is giving the signal to back or shove a train, engine, or car, or the light being used disappears, employees must:

- Stop movement, unless employee on leading car controls the air brakes.

### 5.3.4 Signal to Stop

**Any object waved violently by any person on or near the track is a signal to stop.**

### 5.3.5 Acknowledge Stop Signal

Except when switching, acknowledge hand signal to stop a train. When flagged, the engineer must obtain a thorough explanation from the flagman before proceeding.

### 5.3.6 Radio and Voice Communication

Employees may use radio and other means of voice communication to give information when using hand signals is not practical. Employees must make sure crew members:

- Know which moves will be made by radio communication.
- Understand that while using the radio, the engineer will not accept any hand signals, unless they are Stop signals.

### 5.3.7 Radio Response

When radio communication is used to make movements, crew members must respond to specific instructions given for each movement. Radio communications for shoving movements must specify the direction and distance and must be acknowledged when distance specified is more than four cars.

**Movement must stop within half the distance specified unless additional instructions are received.**

## 5.4 Flags for Temporary Track Conditions

### 5.4.1 Temporary Restrictions

Track bulletins, track warrants, or general orders may restrict or stop train movements because of track conditions, structures or men or equipment. Yellow flags are used to indicate temporary speed restrictions. Yellow-red flags are used to indicate when a train may be required to stop. When flags are not displayed, that information will be included in the track bulletin, track warrant, or general order.

**BNSF Amendment—The last sentence is deleted from the second paragraph:**

When a restriction spans adjoining subdivisions, separate temporary restrictions may be issued on each subdivision. ~~Only one set of flags may be displayed in advance of the entire restriction in each direction.~~

### 5.4.2 Display of Yellow Flag

#### A. Restriction Specified in Writing

**Two Miles Ahead of Restricted Area.** Yellow flags warn trains to restrict movement because of track conditions or structures. To make sure train movement is restricted at the right location, employees must display a yellow flag 2 miles before the restricted area.

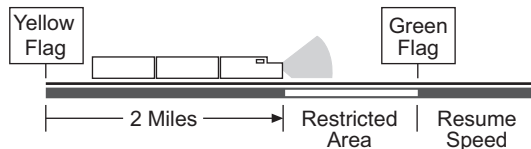

[Diagram A.]

~~**Less than Two Miles Ahead of Restricted Area.** When the restricted area is close to a terminal, junction, or another area, employees will display the yellow flag less than 2 miles before the restricted area. This information will also be included in the track bulletin, track warrant, or general order.~~

**BNSF Amendment—The paragraph “Less than Two Miles Ahead of Restricted Area”, is changed to read:**

**Less than Two Miles Ahead of Restricted Area.** When the restricted area is close to a terminal, junction, or another area or if restriction is on a siding, employees will display the yellow flag less than 2 miles before the restricted area. This information will also be included in the track bulletin, track warrant, or general order.

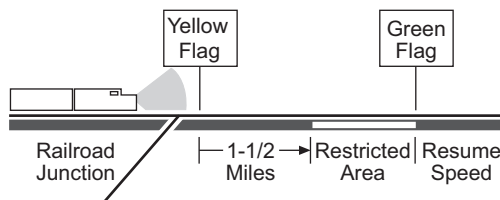

[Diagram B.]

**Once the Train Reaches the Restricted Area.** The speed specified by track warrant, track bulletin, general order, or radio speed restriction must not be exceeded until the rear of the train clears the restricted area.

#### B. Restriction Is Not Specified in Writing

When a yellow flag is displayed and the restriction is not specified by a track bulletin, track warrant, or general order, once the train is 2 miles beyond the yellow flag, crew members must:

1. Continue moving the train but at a speed not exceeding 10 MPH.
2. Resume speed only after the rear of the train has:
  - a. Passed a green flag.
  - or
  - b. Traveled 4 miles beyond the yellow flag and the train dispatcher has verified that no track bulletin or track warrant is in effect specifying a temporary speed restriction at that location.

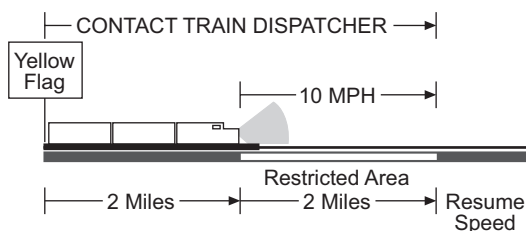

[Diagram C.]

### 5.4.3 Display of Yellow-Red Flag

Maintenance of Way employees may display yellow-red flags from one hour before the track bulletin Form B takes effect until one hour after it expires. During that time, trains may accept instructions from the employee in charge as outlined in Rule 15.2 (Protection by Track Bulletin Form B).

The display of yellow-red flags as described does not extend the authorized working time beyond the times listed on the track bulletin Form B.

#### A. Restriction Specified in Writing

**Two Miles Ahead of Restricted Area.** Yellow-red flags warn a train to be prepared to stop because of men or equipment. To make sure the train is prepared to stop at the right location, employees must display a yellow-red flag 2 miles before the restricted area.

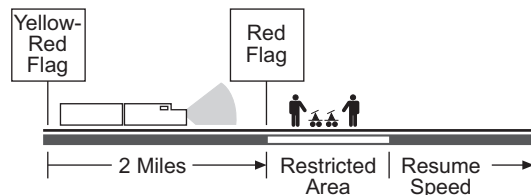

[Diagram A.]

**Less Than Two Miles Ahead of Restricted Area.** When the restricted area is close to a terminal, junction, or another area, employees will display the yellow-red flag less than 2 miles before the restricted area. This information will also be included in the track bulletin, track warrant, or general order.

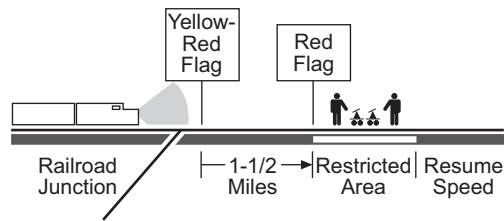

[Diagram B.]

#### B. Restriction Is Not Specified in Writing

When a yellow-red flag is displayed and the restriction is not specified by a track bulletin, track warrant, or general order, crew members must be prepared to stop short of a red flag 2 miles beyond the yellow-red flag. If a red flag is displayed, proceed as outlined in Rule 5.4.7 (Display of Red Flag or Red Light). If no red flag is displayed:

1. Move at restricted speed.
2. Increase speed only after:
  - a. A crew member has received instructions from the employee in charge.
  - or
  - b. The leading wheels of movement are 4 miles beyond the yellow-red flag, and the train dispatcher has verified that no track bulletin or track warrant protecting men or equipment is in effect at that location.

#### 5.4.4 Authorized Protection by Yellow or Yellow-Red Flag

On subdivisions where maximum speed does not exceed 40 MPH, and it is authorized by special instructions, yellow or yellow-red flags may be displayed without the use of track bulletins, track warrants, or flagmen. Yellow or yellow-red flags must be displayed 2 miles before the restricted area. Protection will begin at a point 2 miles beyond the yellow or yellow-red flag and continue for 2 more miles, as outlined in Rule 5.4.2 (Display of Yellow Flag) and Rule 5.4.3 (Display of Yellow-Red Flag).

**Note:** Crew members do not need to receive verification from the train dispatcher when this rule is in effect.

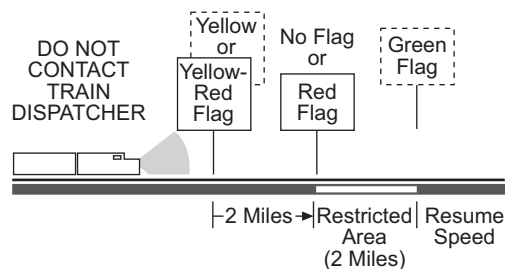

[Diagram A.]

### 5.4.5 Display of Green Flag

A green flag indicates the end of a temporary speed restriction. If a series of locations requires reduced speeds, the green flags could overlap yellow flags. When this is the case, employees must:

- Place a yellow flag before each speed restriction.
- Place a green flag at the end of the last speed restriction.

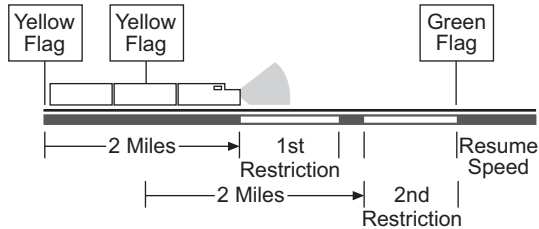

[Diagram A.]

**BNSF Amendment—The following rule is canceled.**

### ~~5.4.6 Display of Flags Within Current of Traffic~~

#### ~~A. Yellow and Green Flags~~

~~Flags for temporary speed restrictions will only be placed for trains moving with the current of traffic.~~

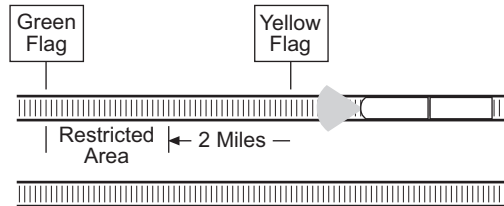

~~[Diagram A.]~~

#### ~~B. Yellow-Red Flags~~

~~Flags protecting men or equipment must be placed in both directions on each track affected.~~

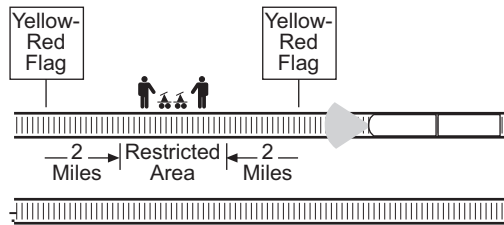

~~[Diagram B.]~~



### 5.4.7 Display of Red Flag or Red Light

A red flag or red light is displayed where trains must stop. When approaching a red flag or red light, the train must stop short of the red flag or red light and not proceed unless the employee in charge gives instructions, including the milepost location of the red flag or red light. A crew member must attempt to contact the employee in charge to avoid delay, giving the location of the red flag or red light and the track being used. If instructions to proceed are received before the train stops, the train may pass the red flag or red light without stopping.

If track bulletin Form B is not in effect, instructions must include speed and distance. This speed must not be exceeded until the rear of the train has passed the specified distance from the red flag or red light, unless otherwise instructed by the employee in charge.

**Displayed Between Rails.** When a red flag or red light is displayed between the rails of a track, the train must stop and not proceed until the flag or light has been removed by an employee of the class that placed it.

### 5.4.8 Flag Location

~~Flags will be displayed only on the track affected. However, when yellow, yellow-red, or red flags or red lights are used for protection without a track bulletin, track warrant, or general order, these flags must be placed to protect all possible access to the restricted area.~~

**BNSF Amendment—The first paragraph is changed to read:**

Flags will be displayed on all main tracks and sidings leading to the track affected.

Flags or red lights must be displayed to the right of the track as viewed from an approaching train. In multiple main track territory or where sidings are adjacent to main track(s), they will be placed on the field side of outside tracks. Red flags or red lights may be displayed between the rails as outlined in Rule 5.4.7 (Display of Red Flag or Red Light). Flags or red lights will be placed in this manner unless otherwise specified by track bulletin, track warrant, special instructions, or general order.

When flags are displayed beyond the first rail of an adjacent track, the flags will not apply to the track on which the train is moving.

## 5.5 Permanent Speed Signs

Permanent speed restriction signs will be placed in advance of permanent speed restrictions. Numbers on the face of these signs indicate the highest speed permitted over the limits of the restriction.

### Two Sets of Numbers

When two sets of numbers are shown, the greater number governs trains consisting entirely of passenger equipment. The lesser number governs all other trains.

### Resume Speed Signs

A permanent resume speed sign or a speed sign showing a higher speed will be placed at the end of each restriction.

Crew members must not exceed the speed shown on each permanent speed restriction sign until the rear of the train:

- Has passed a permanent resume speed sign or a sign showing a higher speed.
- or
- Has cleared the limits of the restriction.

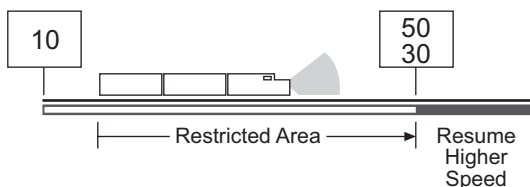

[Diagram A.]

## 5.6 Unattended Fusee

If a train approaches an unattended fusee burning on or near its track, the train must stop consistent with good train handling.

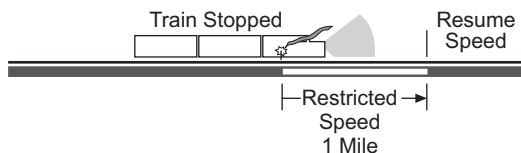

[Diagram A.]

A train moving at restricted speed must stop before passing the fusee.

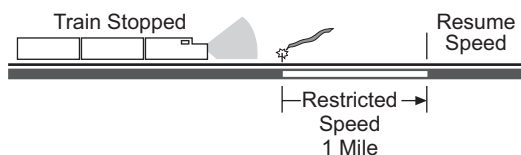

[Diagram B.]

After stopping, the train must proceed at restricted speed for 1 mile beyond the fusee.

If the unattended burning fusee is beyond the first rail of an adjacent track, the fusee does not apply to the track on which the train is moving.

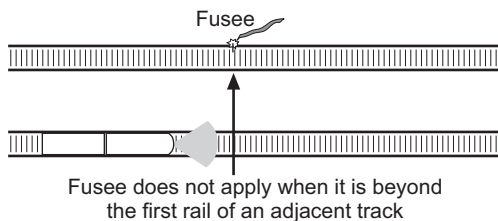

[Diagram C.]

Do not place fuses where they may cause fires.

## 5.7 Not Used

## 5.8 Bell and Whistle Signals

### 5.8.1 Ringing Engine Bell

Ring the engine bell under any of the following conditions:

- Before moving, except when making momentary stop and start switching movements.
- As a warning signal anytime it is necessary.
- When approaching men or equipment on or near the track.

**BNSF Amendment—Add the following fourth bullet:**

- When whistle signal (7) is required.
- Approaching public crossings at grade with the engine in front start signal at the crossing sign. If no sign, or if movement begins between sign and crossing, start signal soon enough before crossing to provide warning. Continue ringing bell until the crossing is occupied.

### 5.8.2 Sounding Whistle

The whistle may be used at anytime as a warning regardless of any whistle prohibitions.

When other employees are working in the immediate area, sound the required whistle signal before moving.

Other forms of communications may be used in place of whistle signals, except signals (1), (7), and (8). See following chart.

The required whistle signals are illustrated by “o” for short sounds and “—” for longer sounds:

<u>Sound</u>	<u>Indication</u>
(1) Succession of short sounds	Use when persons or livestock are on the track at other than road crossings at grade. In addition, use to warn railroad employees when an emergency exists, such as a derailment. When crews on other trains hear this signal, they must stop until it is safe to proceed.
(2) —	When stopped: air brakes are applied, pressure equalized.
(3) — —	Release brakes. Proceed.
(4) o o	Acknowledgment of any signal not otherwise provided for.
(5) o o o	When stopped: back up. Acknowledgment of hand signal to back up.
(6) o o o o	Request for signal to be given or repeated if not understood.
(7) — — o —	When approaching public crossings at grade with the engine in front, sound signal as follows: <ul style="list-style-type: none"> <li>A. At speeds in excess of 45 MPH, start signal at or about the crossing sign but not more than 1/4 mile before the crossing.</li> <li>B. At speeds of 45 MPH or less, start signal at least 15 seconds, but not more than 20 seconds, before entering the crossing.</li> <li>C. If no crossing sign start signal at least 15 seconds, but not more than 20 seconds before entering crossing but not more than 1/4 mile before the crossing.</li> <li>D. If movement starts less than 1/4 mile from a crossing, signal may be sounded less than 15 seconds before the crossing when it is clearly seen traffic is not approaching the crossing, traffic is not stopped at the crossing or when crossing gates are fully lowered.</li> </ul> Prolong or repeat signal until the engine completely occupies the crossing(s).
(8) — o	Approaching men or equipment on or near the track, regardless of any whistle prohibitions.  After this initial warning, sound whistle signal (4) intermittently until the head end of train has passed the men or equipment.

### 5.8.3 Whistle Failure

If the whistle fails to operate and no other unit can be used as the lead unit, continue movement with the bell ringing continuously. Stop the train before each public crossing, so a crew member on the ground can provide warning until the crossing is occupied, unless:

- Crossing gates are in the fully lowered position.
- or
- No traffic is approaching or stopped at the crossing.

### 5.8.4 Whistle Quiet Zone

Within designated whistle quiet zones, whistle signal (7) must not be sounded approaching public crossings at grade except when:

- Necessary to provide warning in an emergency.
  - Notified automatic warning devices are malfunctioning.
  - Notified automatic warning devices are out of service.
- or
- The whistle quiet zone is not in effect during specified hours.

**BNSF Amendment—Add the following:**

A locomotive engineer may sound the train horn to provide warning to crews on other trains in an emergency situation, vehicle operators, pedestrians, trespassers or animals if, in the locomotive engineer's sole judgment, such action is appropriate to prevent imminent injury, death, or property damage. Train crews are not restricted from sounding the horn when:

- There is an emergency situation.
- A wayside horn is malfunctioning.
- Active grade crossing warning devices malfunction.
- Grade crossing warning systems are out of service.
- Supplemental or alternative safety measures are not compliant.
- Needed for purposes other than highway-rail crossing safety, for example, to announce the approach of a train to roadway workers.

All other whistle requirements remain in effect.

## 5.9 Headlight Display

Turn the headlight on bright to the front of every train, except when the light must be dimmed as outlined in Rule 5.9.1 (Dimming Headlight) or turned off as outlined in Rule 5.9.2 (Headlight Off).

### 5.9.1 Dimming Headlight

Approaching public crossings at grade with engine in front, the headlight must be on bright at the crossing sign. If no sign, or if movement begins between sign and crossing, the headlight must be on bright soon enough before the crossing to provide warning. Except when the engine is approaching and passing over a public crossing at grade, dim the headlight during any of the following conditions:

1. At stations and yards where switching is being done.

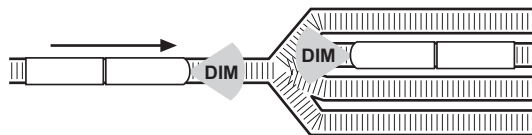

[Diagram A.]

2. When stopped close behind a train.



[Diagram B.]

3. When stopped on the main track waiting for an approaching train. However, when stopped in block system limits, turn the headlight off at the radio request of the crew of an approaching train, until the head end of the train passes.

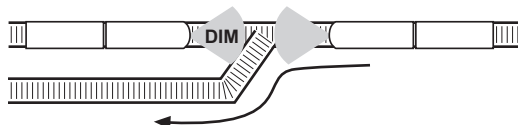

[Diagram C.]

4. When approaching and passing the head end of a train at night.

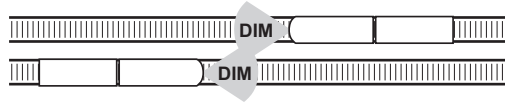

[Diagram D.]

5. At other times to permit passing of hand signals or when the safety of employees requires.

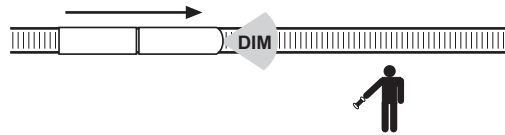

[Diagram E.]

6. When left unattended on a main track in non-signaled territory.

### 5.9.2 Headlight Off

Turn the headlight off under either of the following conditions:

1. The train is stopped clear of the main track

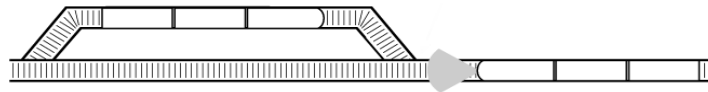

[Diagram A.]

2. The train is left unattended on the main track in block system limit.

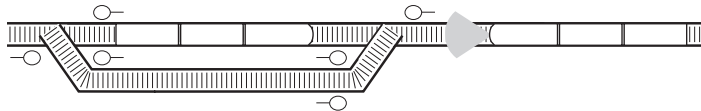

[Diagram B.]

### 5.9.3 Headlight Failure

If the headlight on the train fails, ditch lights must be on, when so equipped. Headlight failure must be reported to the train dispatcher.

At night, if headlight and ditch lights fail to operate and no other unit can be used as the lead unit, continue movement with a white light displayed on the lead unit. Stop the train before each public crossing, so a crew member on the ground can provide warning until the crossing is occupied, unless:

- Crossing gates are in the fully lowered position.
- or
- No traffic is approaching or stopped at the crossing.

#### **5.9.4 Displaying Headlights Front and Rear**

When engines are moving, crew members must turn on the headlight to the front and rear, but may dim or extinguish it on the end coupled to cars.

#### **5.9.5 Displaying Ditch Lights**

Display ditch lights, if equipped, to the front of the train when headlight is on bright.

Locomotives must not be operated as the lead unit out of a train's initial terminal unless both ditch lights are operating. However, if no units are equipped with ditch lights, do not exceed 20 MPH over public crossings until occupied.

If one ditch light fails enroute, the train may proceed, but repairs must be made by the next daily inspection. If two ditch lights fail enroute, the train may proceed, but not exceeding 20 MPH over public crossings until occupied, but must not travel beyond the first point where repairs may be made or until the next daily inspection, whichever occurs first.

#### **5.9.6 Displaying Oscillating White Headlight**

If the leading engine is equipped with an oscillating white headlight, turn the light on when the engine is moving. However, turn the light off when meeting trains, passing trains, or during switching operations, unless movement involves public crossings at grade.

#### **5.9.7 Displaying Oscillating or Flashing Red Light**

If the leading engine is equipped with an oscillating or flashing red light, turn the light on under any of the following conditions:

- Train is stopped suddenly where adjacent tracks may be fouled.
- Head-end protection is required.
- or
- Condition exists that endangers movement.

The red light signals an approaching train on the same or adjacent track to stop at once and to proceed only after the track is safe for train passage. Extinguish red flashing lights when they are no longer needed.

Displaying these lights does not modify the requirements of Rule 6.19 (Flag Protection) or Rule 6.23 (Emergency Stop or Severe Slack Action).

### **5.10 Markers**

A marker of the prescribed type must be displayed on the trailing end of the rear car to indicate the rear of the train.

### 5.10.1 Highly Visible Markers

Display a highly visible marker at the rear of every train as follows:

- From 1 hour before sunset to 1 hour after sunrise.
- When weather conditions restrict visibility to less than 1/2 mile.

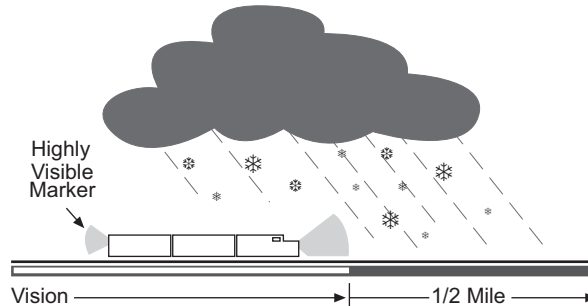

[Diagram A.]

A marker equipped with a functioning photoelectric cell will automatically illuminate at the appropriate time.

When an engine is operating without cars or is at the rear of the train, the trailing headlight illuminated on dim may be used as a marker.

#### Inspection of Marker

When a highly visible marker is required, a qualified employee must inspect it at the initial terminal and at each crew change point. To determine if the marker is functioning properly, the employee will inspect it by observation or by telemetry display in the cab of the engine. The engineer must be informed of the results of the inspection.

### 5.10.2 Alternative Markers

Display a reflector, red flag, or light fixture at the rear of the train as the marker when any of the following conditions exists:

- A highly visible marker is not required.
  - A defective car must be placed at the rear for movement to a repair point.
  - The rear portion of the train is disabled and cannot be moved, and a highly visible marker cannot be displayed on the rear of the portion to be moved.
- or
- The highly visible marker becomes inoperative enroute. If this occurs, notify the train dispatcher and move the train to the next forward location where the highly visible marker can be repaired or replaced.

## 5.11 Engine Identifying Number

Trains will be identified by initials and engine number, adding the direction when required. When an engine consists of more than one unit or when two or more engines are coupled, the number of one unit only will be illuminated as the identifying number. When practical, use the leading unit.

#### **BNSF Amendment—The following exception is added:**

Exception:

- On track bulletins that advise about excessive dimension equipment, trains may be identified by train symbol.
- On track bulletins and on track warrants that do not convey movement authority, passenger trains may be identified by train symbol.

## 5.12 Protection of Occupied Outfit Cars

This rule outlines the requirements for protecting occupied outfit cars. As used in this rule, the following definitions apply:

**Outfit Car.** Any on-track vehicle, including outfit, camp, or bunk car or modular home mounted on a flat car to house railroad employees. Such equipment is not considered an outfit car when placed in a wreck train.

**Effective Locking Device.** When used in relation to a manually operated switch or a derail, a lock that can be locked or unlocked only by the craft or group of workmen applying the lock.

**Rolling Equipment.** Engines, cars, and one or more engines coupled to one or more cars.

**Switch Providing Direct Access.** A switch that if used by rolling equipment could permit the rolling equipment to couple to the equipment being protected.

**Warning Signal.** A white sign that reads “OCCUPIED CAMP CAR” in black lettering. At night, an illuminated white light must also be used.

When occupied outfit cars are placed on a track, the employee in charge of the outfit car occupants (or a designated representative) must provide or request protection using one of the following methods:

### A. On a Main Track

One of these two methods or a combination of these methods must be provided:

1. Each manually operated switch that provides direct access to that portion of the main track where occupied outfit cars are located must be lined against movement to that track, secured with an effective locking device, and spiked or clamped. Warning signals must be displayed at or near each switch.

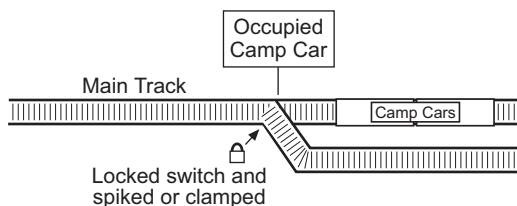

[Diagram A.]

2. If remote control switches provide direct access to the main track where occupied outfit cars are located, the control operator will line the switch against movement to that track and apply blocking devices to the control machine to prevent movement onto that track. The control operator must complete the above tasks before informing the employee requesting protection that protection is provided.

**Blocking devices must not be removed until the employee in charge of the outfit car occupants (or a designated representative) informs the control operator that protection is no longer required.**

- a. Warning signals must be displayed at or near each remote control switch.
- b. In addition, a derail capable of restricting access to the portion of main track where occupied outfit cars are located must be placed at least 150 feet from the end of the occupied outfit cars. The derail must be locked in derailing position with an effective locking device. Warning signals must be displayed at each derail.



- c. The control operator must maintain for 15 days a written record of each notification. The record must contain the following information:
  - Name and craft of employee requesting protection.
  - Identification of track protected.
  - Date and time employee in charge of outfit car occupants is notified that protection was provided.
  - Date, time, name, and craft of employee authorizing removal of protection.

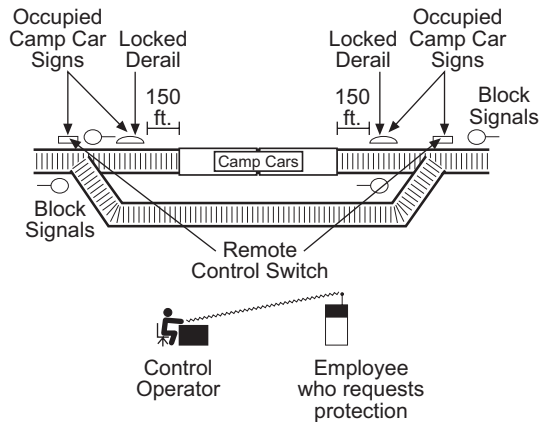

[Diagram B.]

**B. On Other Than a Main Track**

One of these three methods of protection or a combination of these methods must be provided:

1. Each manually operated switch that provides direct access to the track where occupied outfit cars are located must be lined against movement to that track and secured with an effective locking device. Warning signals must be displayed at or near each switch.

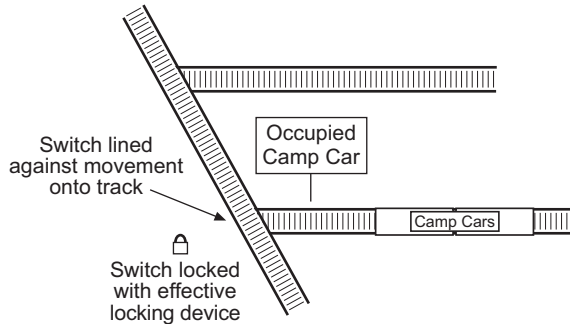

[Diagram C.]

2. If remote control switches provide direct access to the track where occupied outfit cars are located, the control operator will line the switch against movement to that track and apply blocking devices to the control machine to prevent movement onto that track. The control operator must complete the above tasks before informing the employee requesting protection that protection is provided.

**Blocking devices must not be removed until the employee in charge of the outfit car occupants (or a designated representative) informs the control operator that protection is no longer required.**

- a. Warning signals must be displayed at or near each remote control switch.

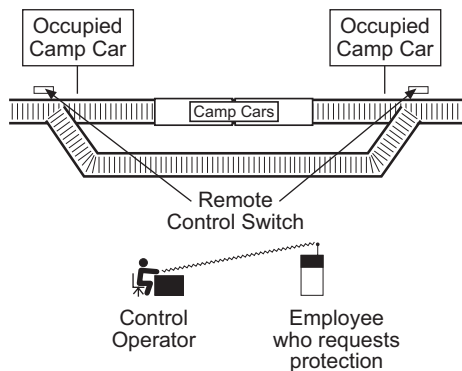

[Diagram D.]

- b. The control operator must maintain for 15 days a written record of each notification. The record must contain the following information:
- Name and craft of employee requesting protection.
  - Identification of track protected.
  - Date and time employee in charge of outfit car occupants is notified that protection was provided.
  - Date, time, name, and craft of employee authorizing removal of protection.
3. A derail capable of restricting access to that portion of the track where occupied outfit cars are located will fulfill the requirements of protection when the derail is:
- a. Positioned at least 150 feet from the end of the occupied outfit cars.
  - or
  - b. Positioned at least 50 feet from the end of the occupied outfit cars where the maximum speed on that track is 5 MPH.

Warning signals must be displayed at each derail.

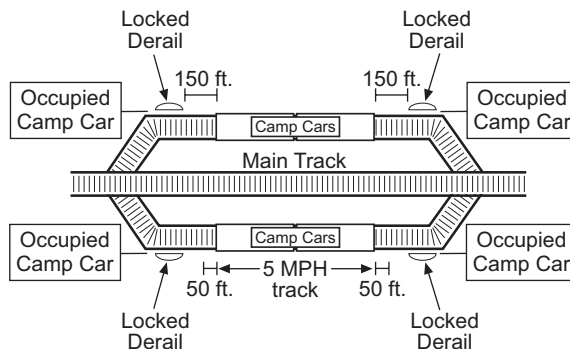

[Diagram E.]

### C. Warning Signals

When a warning signal is displayed to protect occupied outfit cars:

1. Occupied outfit cars must not be coupled to or moved.
2. Rolling equipment must not pass the warning signal.
3. Rolling equipment must not be placed on the same track in a manner that would block or reduce the crew's view of the warning signal.

## 5.13 Blue Signal Protection of Workmen

This rule outlines the requirements for protecting railroad workmen who are inspecting, testing, repairing, and servicing rolling equipment. In particular, because these tasks require the workmen to work on, under, or between rolling equipment, workmen are exposed to potential injury from moving equipment.

As used in this rule, the following definitions apply:

**Workmen.** Railroad employees assigned to inspect, test, repair, or service railroad rolling equipment or components, including brake systems. Train and yard crews are excluded, except when they perform the above work on rolling equipment not part of the train or yard movement they are handling or will handle.

- “Servicing” does not include supplying cabooses, engines, or passenger cars with items such as ice, drinking water, tools, sanitary supplies, stationery, or flagging equipment.
- “Testing” does not include an employee making visual observations while on or along side a caboose, engine, or passenger car. Also, testing does not include repositioning the activation switch or covering the photoelectric cell of the marker when the rear of the train is on the main track. The employee inspecting the marker must contact the employee controlling the engine to confirm that the train will remain secure against movement until the inspection is complete.

**Group of Workmen.** Two or more workmen of the same or different crafts who work as a unit under a common authority and communicate with each other while working.

**Rolling Equipment.** Engines, cars, and one or more engines coupled to one or more cars.

**Blue Signal.** During the day, a clearly distinguishable blue flag or light, and at night, a blue light. The blue light may be steady or flashing.

The blue signal does not need to be lighted when it is attached to the operating controls of an engine and the inside of the engine cab area is lighted enough to make the blue signal clearly distinguishable.

**Effective Locking Device.** When used in relation to a manually operated switch or a derail, a lock that can be locked or unlocked only by the craft or group of workmen applying the lock.

**Car Shop Repair Area.** One or more tracks within an area where rolling equipment testing, servicing, repairing, inspecting, or rebuilding is controlled exclusively by mechanical department personnel.

**Engine Servicing Area.** One or more tracks within an area where engine testing, servicing, repairing, inspecting, or rebuilding is controlled exclusively by mechanical department personnel.

**Switch Providing Direct Access.** A switch that if used by rolling equipment could permit the rolling equipment to couple to the equipment being protected.

### A. What a Blue Signal Signifies

A blue signal signifies that workmen are on, under, or between rolling equipment and requires that:

1. Rolling equipment must not be coupled to or moved, except as provided in “**Movement in Engine Servicing Area**” and “**Movement in Car Shop Repair Area**” of this rule.
2. Rolling equipment must not pass a blue signal on a track protected by the signal.
3. Other rolling equipment must not be placed on the same track so as to block or reduce the view of the blue signal.
  - a. However, rolling equipment may be placed on the same track when it is placed on designated engine servicing area tracks or car shop repair area tracks, or when a derail divides a track into separate working areas.

4. Rolling equipment must not enter a track when a blue signal is displayed at the entrance to the track.

Blue signals or remote control blue signals must be displayed for each craft or group of workmen who will work on, under, or between rolling equipment.

**Protection Removed.** Blue signals may be removed only by the craft or group who placed them. Remote control display may be discontinued when directed by the craft or group that requested the protection. When blue signal protection has been removed from one entrance of a double-ended track or from either end of rolling equipment on a main track, that track is no longer under blue signal protection.

**B. How to Provide Protection**

When workmen are on, under, or between rolling equipment and exposed to potential injury, protection must be provided as follows:

**On a Main Track.** A blue signal must be displayed at each end of the rolling equipment.

**On Other than a Main Track.** One of these three methods of protection or a combination of these methods must be provided:

1. Each manually operated switch, including any facing point crossover switch that provides direct access must be lined against movement onto the track and secured by an effective locking device. A blue signal must be placed at or near each such switch.

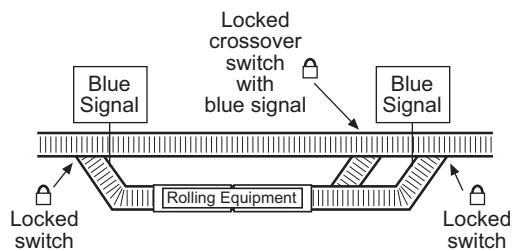

[Diagram A.]

2. A derail capable of restricting access to the track where work will occur must be locked in derailing position with an effective locking device and:
  - a. Positioned at least 150 feet from the rolling equipment to be protected.
  - or
  - b. Positioned at least 50 feet from the end of rolling equipment on a designated engine servicing track or car shop repair track where speed is limited to not more than 5 MPH. A blue signal must be displayed at each derail.

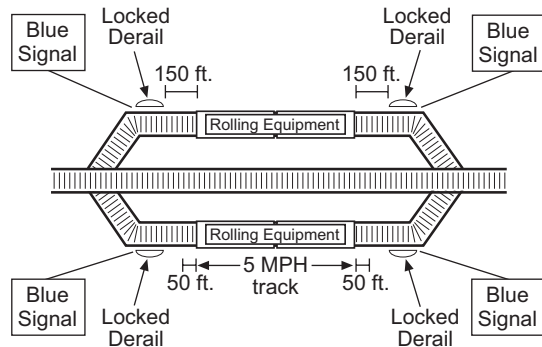

[Diagram B.]

3. Where remote control switches provide direct access, the employee in charge of the workmen must tell the switch operator what work will be done. The switch operator must then:
  - a. Inform the employee in charge of the workmen that the switches have been lined against movement onto the track and devices controlling the switches have been secured.
  - b. Not remove the locking devices unless the employee in charge of the workmen says it is safe to do so.
  - c. Maintain for 15 days a written record of each notification that includes:
    - Name and craft of the employee in charge of the workmen requesting protection.
    - Identification of track involved.
    - Date and time the employee in charge of workmen is notified that protection was provided.
    - Date, time, name, and craft of the employee in charge of workmen who authorized removal of the protection.

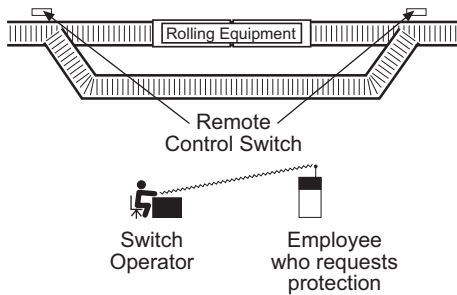

[Diagram C.]

**C. Blue Signal Readily Visible to Engineer**

In addition to providing protection as required in “On a Main Track” and “On Other than a Main Track,” when workmen are on, under, or between an engine or rolling equipment coupled to an engine:

1. A blue signal must be attached to the controlling engine and be visible to the engineer or employee controlling the engine.
2. Engines equipped for remote control operations must be in manual.
3. ~~The engine must not be moved.~~

**BNSF Amendment—Item 3 is changed to read:**

3. The engine must not be moved. The controls must not be changed unless directed by individuals who placed the blue signal protection.

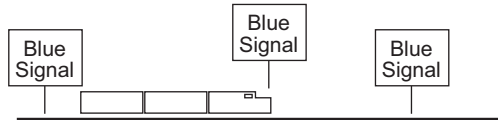

[Diagram D.]

**D. Protection for Workmen Inspecting Markers**

Blue signal protection must be provided for workmen when they are:

1. Replacing, repositioning, or repairing a marker, and the rear of the train is on any track.  
or
2. Inspecting a marker by repositioning the activation switch or covering the photoelectric cell, and the rear of the train is on other than a main track.

**E. Protection for Emergency Repair Work on a Main Track**

If a blue signal is not available for employees performing emergency repairs on, under, or between an engine or rolling equipment coupled to an engine on a main track, the employee controlling the engine must be notified and appropriate measures taken to provide protection for the employees.

**F. Movement in Engine Servicing Area**

An engine must not enter a designated engine servicing area until the blue signal protection is removed from the entrance. The engine must stop short of coupling to another engine.

An engine must not leave a designated engine servicing area unless the blue signal is removed from the engine and the track in the direction of movement.

Blue signal protection removed to let engines enter or leave the engine servicing area must be restored immediately after the engine enters or clears the area.

An engine protected by blue signals may be moved on a designated engine servicing area track when:

1. An authorized employee operates the engine under the direction of the employee in charge of workmen.
2. The blue signal has been removed from the controlling engine to be repositioned.
3. Workmen have been warned of the movement.

**G. Movement in Car Shop Repair Area**

When rolling equipment on car shop repair tracks is protected by blue signals, a car mover may reposition the equipment if:

1. Workmen have been warned of the movement.
2. An authorized employee operates the car mover under the direction of the employee in charge of workmen.

**5.13.1 Utility Employees**

This rule outlines the requirements for allowing utility employees to work without blue signal protection. As used in this rule, a Utility Employee is a railroad employee assigned as a temporary member of a train or yard crew.

**A. Requirements to Start Work**

A utility employee may work as a member of only one train or yard crew at a time.

No more than three utility employees may work with one train or yard crew at the same time.

A utility employee may become a member of a train or yard crew under the following conditions:

- The utility employee communicates with the designated crew member of the train or yard crew before starting work. Communication may be conducted verbally or by radio.
- The designated crew member identifies the utility employee to each member of the crew and each crew member acknowledges the utility employee's presence.
- The designated crew member authorizes the utility employee to work as a temporary member of the crew.

**B. Requirements While Working On, Under, or Between**

Before a utility employee may work on, under, or between rolling equipment, the following applies:

- All members of the crew must communicate with each other to understand the work to be done.
- The engineer must be in the cab of the assigned controlling locomotive. However, another member of the same crew may replace the engineer when the locomotive is stationary.

**C. Requirements When Work Ends**

A utility employee is released from a train or yard crew when:

- The utility employee notifies the designated crew member that the work is completed.
- The designated crew member notifies each crew member that the utility employee is being released.
- The designated crew member releases the utility employee from the train or yard crew, after each crew member acknowledges this notice.

## 5.14 Signs Protecting Equipment

When a sign reading:

**STOP—TANK CAR CONNECTED**

**STOP—MEN WORKING**

**EMPLOYEES WORKING**

**SERVICE CONNECTIONS**

or a similar warning is displayed on a track or car, the car must not be coupled to or moved. Other equipment must not be placed on the same track in a manner that would block or reduce the view of the sign.

## 5.15 Improperly Displayed Signals

If a signal is improperly displayed, or a signal, flag, or sign is absent from the place it is usually shown, regard the signal as displaying the most restrictive indication it can give. However, if a semaphore arm is visible, it will govern.

Promptly report improperly displayed signals or absent fixed signals, flags, or signs to the train dispatcher.

**This page left blank intentionally.**



## 6.0 Movement of Trains and Engines

### 6.1 Repeat Instructions

An employee who verbally receives instructions or information about train or engine movements must repeat them.

### 6.2 Initiating Movement

Before initiating movement on a main track, a crew member must:

~~• Receive a track warrant.~~

**BNSF Amendment—The first bullet is changed to read:**

- Receive a track warrant or general track bulletin.

or

- Determine from the train dispatcher or yardmaster if any track bulletins are needed.

#### 6.2.1 Train Location

~~Trains or maintenance of way employees who receive authority to occupy the main track after the arrival of a train or to follow a train must ascertain the train's location by one of the following methods:~~

**BNSF Amendment—The first sentence is changed to read:**

Trains who receive authority to occupy the main track after the arrival of a train or to follow a train must ascertain the train's location by one of the following methods:

- Visual identification of the train.
  - Direct communication with a crew member of the train.
- or
- Receiving information about the train from the train dispatcher or control operator.

### 6.3 Main Track Authorization

Do not occupy main tracks unless authorized by one of the following:

- Rule 6.13 (Yard Limits).
- Rule 6.14 (Restricted Limits).
- Rule 6.15 (Block Register Territory).
- Rule 9.14 (Movement with the Current of Traffic).
- Rule 9.15 (Track Permits).
- Rule 10.1 (Authority to Enter CTC Limits).
- Rule 14.1 (Authority to Enter TWC Limits).
- Rule 14.6 (Movement Against the Current of Traffic).
- Rule 15.3 (Authorizing Movement Against the Current of Traffic).
- Rule 15.4 (Protection When Tracks Removed from Service).
- Rule 16.1 (Authority to Enter DTC Limits).
- At manual interlockings, verbal authority from the control operator or a controlled signal that indicates proceed.
- Special instructions or general order.

When unable to obtain authority and it is necessary to foul or occupy a main track in ABS, protection must be provided in both directions as outlined under Rule 9.17.1 (Signal Protection in ABS by Lining Switch).

Written authorities that are no longer in effect must be retained until the end of tour of duty, unless otherwise instructed by the train dispatcher.

#### **Joint Authority**

~~When a train or employee receives authority joint with employee(s), the train or employee must not occupy the overlapping limits until:~~

- ~~• Working limits are described and permission is received to enter the overlapping limits from the employee(s) listed on the authority.~~
- ~~or~~
- ~~• Advice is received from the train dispatcher or control operator that the employee(s) have reported clear of the limits.~~

**BNSF Amendment—The paragraph titled Joint Authority is deleted, and the following is added:**

#### **Overlapping Limits**

When a train receives track and time, track warrant or track permit authority joint with an employee or OCS permission joint with an employee, the train must not occupy the overlapping limits until permission is received to enter the overlapping limits from the employees listed on the authority or on the OCS permission.

### **6.3.1 Train Coordination**

Train Coordination provides for men or equipment to use a train's authority to establish working limits. The employee must contact the train's engineer to request use of Train Coordination. To establish working limits:

- The train must be in view and stopped.
- The employee in charge of working limits will communicate with the engineer who will notify other crew members that working limits are to be established.
- The engineer will make movements only as permitted by the employee in charge until the working limits have been released to the engineer.
- The train will not release its authority within the limits until those working limits have been released by the employee in charge.

#### **Establish Working Limits**

Working limits may be established within a train's authority limits as follows:

##### **A. DTC or TWC Territory**

1. With a train having authority to move in either direction that is not joint.
- or
2. With a train having authority to move in one direction only, working limits must not be established:
  - Behind the train.
  - More than one block in advance of the train or beyond any location that a train or engine could enter the track between the employee in charge of the working limits and the train.

##### **B. Rule 9.15 (Track Permit)**

With a train having the only track permit authority within the limits.

##### **C. Rule 9.14 (Current of Traffic)**

With a train having authority to move with the current of traffic, working limits must not be established:

- Behind the train.
- More than one block in advance of the train or beyond any location that a train or engine could enter the track between the employee in charge of the working limits and the train.

**D. CTC Territory**

1. With a train having track and time authority that is not joint.  
or
2. With a train having authority to move in one direction only, working limits must not be established:
  - Behind the train.
  - More than one block in advance of the train or beyond any location that a train or engine could enter the track between the employee in charge of the working limits and the train.

**BNSF Amendment—The following rule is added:**

**E. Train Coordination - OCS Territory**

Employees may use a train's permission in OCS territory in the same manner as using a train's authority. Working limits may be established within a train's OCS limits as follows:

1. With a train having permission to move in either direction that is not joint,  
or
2. With a train having permission to move in one direction only, working limits must not be established:
  - Behind the train.
  - More than one block in advance of the train or beyond any location that a train or engine could enter the track between the employee in charge of the working limits and the train.

**6.4 Reverse Movements**

Make reverse movements on any main track, controlled siding, or on any track where a block system is in effect at restricted speed and only within the limits a train has authority to occupy the track.

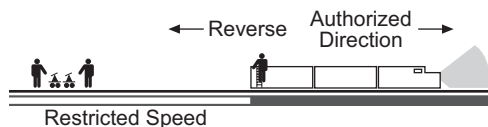

[Diagram A.]

**6.4.1 Permission for Reverse Movements**

Obtain permission from the train dispatcher or control operator before making a reverse movement, unless the movement is within the same signaled block.

When a train or engine is advised that working limits have been established behind their train, obtain permission from the employee in charge to make any reverse movements, including within the same signaled block.

**6.4.2 Movements Within Control Points or Interlockings****A. Control Points or Manual Interlockings**

Except within track and time limits, if movement stops while the trailing end is between the outer opposing absolute signals of a control point or manual interlocking, the movement must not change direction without permission from the control operator.

**B. Automatic Interlockings**

At an automatic interlocking, the movement may change direction within the limits of the interlocking if it continuously occupies at least one car length of the limits.

## 6.5 Shoving Movements

### **BNSF Amendment—Entire rule is changed to read:**

Cars or engines must not be shoved until the engineer knows who is protecting the movement and how protection will be provided. The employee providing protection for the movement shall not engage in any task unrelated to the movement.

When cars or engines are shoved, crew member must be in position and provide visual protection unless relieved by:

- Local instructions for tracks equipped with shove lights/cameras.
- Special instructions specific to tracks involved.
- Rule 6.6 (Picking Up Crew Member).
- Pullout move within an activated Remote Control Zone (RCZ)

Minimum requirements when radio communication is used during shoving movements:

- Direction will be described in relationship to the front of the controlling locomotive (F stencil).
- To instruct the engineer to move the locomotive forward use “ahead”.
- To instruct the engineer to move the locomotive backward use “backup”.
- To instruct the engineer to stop, use the word “stop”.
- Communicate distance using 50 feet as a standard for one car length.
- Engineer must acknowledge the distance, when more than four cars.

Movement must be stopped within half of the distance specified unless additional instructions are received.

Note: Employees are encouraged to communicate additional information related to shoving movements (e.g. switch / derail position, close clearance conditions, stop signals, authority limits, etc).

When cars or engines are shoved on a main track or controlled siding in the direction authorized, movement must not exceed:

- 20 MPH for freight trains.
- 30 MPH for passenger trains.

When engaged in snow plow operations:

- One common authority may be used by both maintenance of way employees and the train crew when all employees are on the equipment,
- Maximum timetable speed applies unless a higher speed is authorized by the employee in charge.
- Employees are relieved from providing visual protection for snow plow being shoved.

Cars or engines must not be shoved to block other tracks until it is safe to do so.

### 6.5.1 Remote Control Movements

Remote control movements are considered shoving movements, except when the remote control operator controlling the movement is riding the leading engine in the direction of movement. Before initiating movement, the remote control operator or a crew member must be in position to visually observe the direction the equipment moves.

#### **Relief of Providing Protection**

The remote control operator is relieved from providing protection and the requirement to stop within half the range of vision for movements with engine on leading end when:

1. The remote control zone has been activated.
2. Switches/derails are known to be properly lined.
3. Track(s) within the zone are known to be clear of other trains, engines, railroad cars, and men or equipment fouling track.

This must be repeated each time the remote control zone is activated.

## 6.6 Picking Up Crew Member

A train may back up on any main track or on any track where CTC is in effect to pick up a crew member under the following conditions:

1. The train dispatcher gives permission to make the movement and verifies the following:
  - a. Another authority is not in effect within the same or overlapping limits unless conflicting movements are protected.
  - b. A track bulletin Form B is not in effect within the same or overlapping limits.
  - c. A main track is not removed from service by a track bulletin within the same or overlapping limits.
2. Movement is limited to the train's authority.
3. Movement does not enter or foul a private or public crossing except as provided by Rule 6.32.1 (Providing Warning Over Road Crossings).
4. Movement will not be made into or within yard limits, restricted limits, interlocking limits, drawbridges, railroad crossings at grade, or track bulletin Form B limits.
5. Movement does not exceed the train's length.

**BNSF Amendment—The following paragraph is added:**

Before a crew requests and makes a move under this rule, a job safety briefing between crew members must be conducted that includes:

- Confirmation of authority limits.
- Location of nearest affected road crossings in direction of movement.
- Distance to be shoved.
- Confirmation that train is intact, verified either visually or by determining that brake pipe continuity exists using end-of-train device or distributed power telemetry.

When movement is made under these conditions, restricted speed does not apply. Trains backing up under the provisions of this rule may pass signals indicating Stop and Proceed, without stopping.

## 6.7 Remote Control Zone

### A. Entering Remote Control Zone

Before entering a remote control zone, all employees that are not part of the remote control crew must determine whether the zone is activated. Employees may receive this information from the remote control operator, other authorized employee, or special instructions.

~~When the remote control zone is activated, track(s) within the zone must not be fouled with equipment, occupied, or switches operated until the remote control zone has been deactivated or permission is granted by the remote control operator to enter the remote control zone.~~

**BNSF Amendment—The 2nd paragraph is changed to read:**

When the remote control zone is activated, track(s) within the zone must not be fouled with equipment, occupied, or switches operated until the remote control zone has been deactivated.

~~Protection must be provided while other employees are in the remote control zone. The remote control operator must know the track is clear and switches are properly lined after other employees are clear of the remote control zone.~~

**BNSF Amendment—The 3rd paragraph is deleted in its entirety.**

### B. Transfer of an Active Remote Control Zone

An active remote control zone may be transferred to other remote control operators. A job briefing must be conducted each time the zone is transferred between remote control operators and, if applicable, other authorized employee.

### C. Deactivating Remote Control Zone

When the remote control operator ends the tour of duty, the remote control zone must be deactivated except the remote control zone may remain active if:

- Transferred.
- or
- Special instructions specify the hours the remote control zone is active.

## 6.8 Stopping Clear for Meeting or Passing

A train that may be met or passed must stop at least 400 feet from the signal or clearance point of the facing point switch the other train will pass over, if length of train permits.

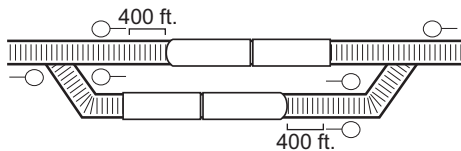

[Diagram A.]

## 6.9 Meeting or Passing Precautions

A train required to take siding must stop clear of the switch, unless the switch is properly lined to leave the main track.

A train standing on the main track to meet an opposing train must, if possible, line the switch for the opposing train to leave the main track. However, within ABS, do not line the switch until the opposing train has entered the block in advance.

## 6.10 Instructions to Clear a Following Train

If the train dispatcher instructs a train within block system limits to clear a following train, the train must be in the clear before the following train could receive a restrictive signal indication.

Determine the location of the following train by radio or other means of communication.

## 6.11 Mandatory Directive

Mandatory directives are written, printed, or displayed authorities or speed restrictions issued by the train dispatcher or control operator. Mandatory directives are:

- Track warrants.
- Track bulletins.
- DTC authority.
- Track and time.
- Track permits.
- Radio speed restrictions.

A mandatory directive restricting a train's movement will not be issued near a point where the restriction applies until the engineer or conductor confirms that the train can comply with the restriction.

Indicate "VOID" on mandatory directive form when:

- Employee reports clear of authority limits,
- or
- Mandatory directive is made void

Crew must retain mandatory directives for continuous tour of duty.

### 6.12 FRA Excepted Track

On a track designated as “FRA Excepted Track,” the following will govern:

- Maximum speed must not exceed 10 MPH.
- No occupied passenger train will be operated.
- No movement will be operated that contains more than five cars placarded according to Hazardous Material Regulations.

### 6.13 Yard Limits

Within yard limits, trains or engines are authorized to use the main track not protecting against other trains or engines, only after obtaining a track warrant, listing all track bulletins that affect their movement. Engines must give way as soon as possible to trains as they approach. Engines must keep posted as to the arrival of passenger trains and must not delay them.

All movements entering or moving within yard limits must be made at restricted speed unless operating under a block signal indication that is more favorable than Approach.

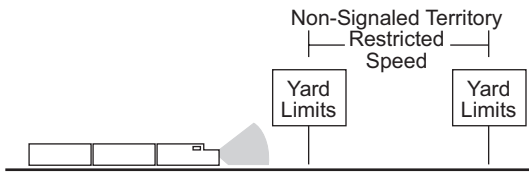

[Diagram A.]

Upon observing or having advance knowledge that a block signal may require restricted speed due to yard limits, if entering or within yard limits, the movement must be at restricted speed at that block signal, or as soon as possible thereafter, consistent with good train handling.

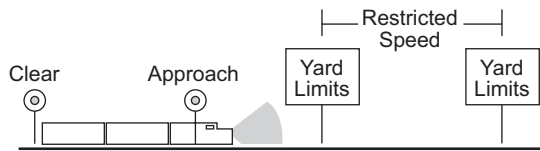

[Diagram B.]

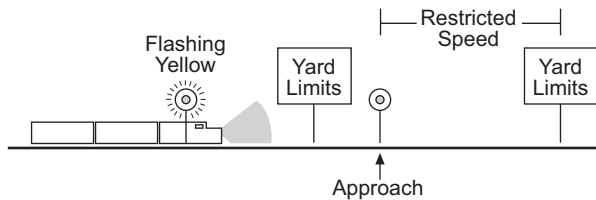

[Diagram C.]

Yard limits remain in effect continuously unless otherwise specified by special instructions or track bulletin.

**Against the Current of Traffic**

Movements against the current of traffic must not be made unless authorized or protected by track warrant, track bulletin, yardmaster, or other authorized employee.

**In CTC Territory**

Where yard limits are in effect in CTC territory, the control operator must authorize any movement on the main track. Reverse movements within the same block may be made as outlined in Rule 6.4.1 (Permission for Reverse Movements).

**In Track Permit Territory**

Where yard limits are in effect in Rule 9.15 (Track Permit) territory, all movements must receive permission from the control operator to enter the main track or to cross over from one main track to another as follows:

- A controlled signal displays a proceed indication.
- A track permit is issued.
- or
- Verbal permission is granted if no track permit is in effect. Rule 9.17 (Entering Main Track at Hand-Operated or Spring Switch) applies.

**6.14 Restricted Limits**

Between designated points specified by signs and in the special instructions, trains and engines are authorized to use the main track not protecting against other trains or engines, only after obtaining a track warrant, listing all track bulletins that affect their movement. All movements must be made at restricted speed.

Movements against the current of traffic must not be made unless authorized or protected by track warrant, track bulletin, yardmaster, or other authorized employee.

**6.15 Block Register Territory (BRT)**

Block register territory will be designated in the special instructions. A register labeled “Block Register Territory” will apply only on that designated territory. A train or employee in charge of men or equipment is authorized to occupy block register territory under the following conditions:

- The following information is in the register on first blank line:

Train, gang, or equipment identification	Conductor or employee in charge of men or equipment	Date	Time territory occupied	Time territory cleared
A	B	C	D	E

**Column Required Entry**

- A ..... Enter the train, gang, or equipment identification.
- B ..... Enter last name of conductor or employee in charge of men or equipment.
- C ..... Enter current date.
- D ..... Enter time entry is made in register.
- E ..... Enter time the territory was cleared. Then, draw a line through the entire entry. The required exit entry may be completed by any authorized employee.

- If the register indicates the territory is occupied, entry cannot be made on the register until the employee in charge or engineer of each preceding entry has been contacted. When the territory is jointly occupied, movements must be made at restricted speed.



## 6.16 Approaching Railroad Crossings, Drawbridges, and End of Multiple Main Track

Trains and engines must be prepared to stop when they approach railroad crossings at grade, drawbridges, and the end of multiple main track, unless these areas are protected by block or interlocking signals.

### Protected by Stop Signs

If stop signs protect these areas, the train must stop before any part of the train or engine passes the stop sign. The train cannot proceed until the route is clear or drawbridge position permits movement.



[Diagram A.]

### Protected by Gate

If a gate is lined against the intended route, trains and engines must stop and remain at least 50 feet from fouling the track on the conflicting route until the gate is changed to the stop position on the conflicting route. Where required, restore gate to its normal position after movement is complete.

### Obscured View of Conflicting Route

If a train must stop before entering a railroad crossing at grade and the view on the conflicting route is obscured, a crew member must go ahead of the train and signal from the crossing when it is safe to proceed.

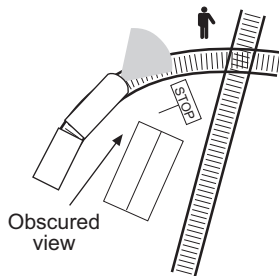

[Diagram B.]

## 6.17 Switches at Junctions

The normal position for a junction switch is for through movement on the main track where the junction is an intermediate station

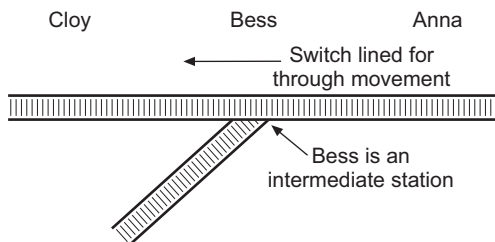

[Diagram A.]

## 6.18 Stopping Clear of Crossings and Junctions

At a railroad crossing or junction, a train or engine must not stop, if possible, where it could interfere with train movement on the other track.

## 6.19 Flag Protection

### A. Flag Protection Not Required

Flag protection is not required against following trains on the same track if:

1. Train is within ABS limits and the rear of the train is protected by at least two block signals or one block signal and one distant signal.
  2. Rear of the train is within BRT, CTC, DTC, TWC or interlocking limits.
- or
3. General order or special instructions specify that flag protection is not required.

### B. Flag Protection is Required

When flag protection is required against following trains:

1. More Than Half the Maximum Timetable Speed

When a train is moving on a main track at or more than half the maximum authorized timetable speed for any train at that location, and the train may be overtaken by a following train, a flagman must decide whether to drop lighted fuseses by considering the following:

- Grade of the track.
- Curvature of the track.
- Weather conditions.
- Sight distance.
- Speed of the train relative to a following train.

2. Less than Half the Maximum Timetable Speed

When a train is moving on a main track at less than half the maximum authorized timetable speed for any train at that location, a flagman must provide flag protection against following trains on the same track. The flagman must drop off single lighted fuseses at close enough intervals to ensure full protection and not exceed the burning time of the fusee.

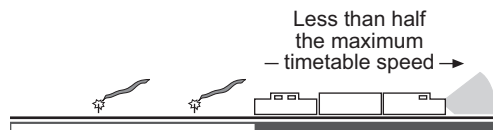

[Diagram A.]

3. Stopped on a Main Track

When a train stops on a main track, a flagman must immediately go back at least 1 mile. Flagman must remain there until stopping a following train or until recalled.

If the flagman is recalled and safety will permit, the flagman must leave a lighted fusee and return to the train. If recalled before reaching the prescribed distance, the flagman must leave a lighted fusee. While returning to the train, the flagman must also place single lighted fusees at intervals shorter than the burning time of the fusee.

When the train departs, a crew member must leave one lighted fusee. In addition, until the train is moving at least half the maximum authorized timetable speed for any train at that location, a crew member must drop off single lighted fusees at intervals shorter than the burning time of the fusee.

## 6.20 Equipment Left on Main Track

### A. Portion of Train Left on Main Track

When necessary to leave a portion of a train temporarily on the main track, follow this procedure:

- Set a sufficient number of hand brakes to keep the detached portion from moving.
- Provide protection against movements that may enter the main track between the detached portion and the returning front portion unless:
  - The train dispatcher verbally relieves the protection.
  - or
  - The return movement is otherwise authorized.
- Make return movement at restricted speed. However, an engine without cars may return at a higher speed when governed by block signal indication.

### B. Other Equipment Left on Main Track

Crews that leave equipment on the main track do not need to provide protection for the equipment if the train dispatcher gives verbal relief.

The train dispatcher may request a crew to report clear of their authority and leave equipment on a main track. Crews that leave equipment on a main track do not need to provide protection for the equipment if the train dispatcher provides relief. The train dispatcher must provide protection for the equipment.

All crews that use the main track at that point must be notified of the equipment location and must move at restricted speed when approaching that location.

## 6.21 Precautions Against Unusual Conditions

Protect trains and engines against any known condition that may interfere with their safety.

When conditions restrict visibility, regulate speed to ensure that crew members can observe and comply with signal indications.

In unusually heavy rain, storm, or high water, trains and engines must approach bridges, culverts, and other potentially hazardous points prepared to stop. If they cannot proceed safely, they must stop until it is safe to resume movement.

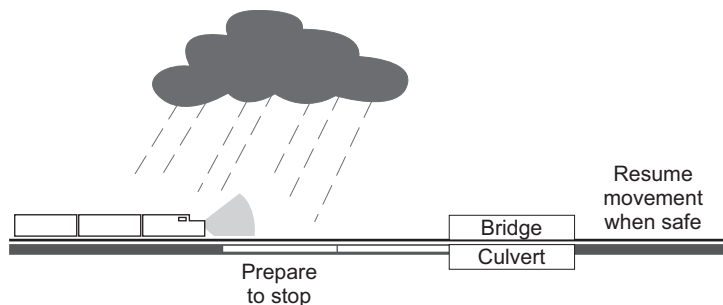

[Diagram A.]

Advise the train dispatcher of such conditions by the first available means of communication.

### 6.21.1 Protection Against Defects

If any defect or condition that might cause an accident is discovered on tracks, bridges, or culverts, or if any crew member believes that the train or engine has passed over a dangerous defect, the crew member must immediately notify the train dispatcher and provide protection if necessary.

### 6.21.2 Water Above Rail

Do not operate trains and engines over tracks submerged in water until the track has been inspected and verified as safe.

Operate engines at 5 MPH or less when water is above the top of the rail. If water is more than 3 inches above the top of the rail, a mechanical department supervisor must authorize the movement.

## 6.22 Maintaining Control of Train or Engine

Crew members must consider train or engine speed, grade conditions, and air gauge indications to determine that the train or engine is being handled safely and is under control. If necessary, take immediate action to bring the train or engine under control.

## 6.23 Emergency Stop or Severe Slack Action

When a train or engine is stopped by an emergency application of the brakes or severe slack action occurs while stopping, take the following actions:

### Obstruction of Main Track or Controlled Siding

If an adjacent main track or controlled siding may be obstructed, immediately:

- Warn other trains by radio, stating the exact location and status of the train and repeat as necessary.
- Place lighted fusees on adjacent tracks.
- Notify the train dispatcher or control operator and, when possible, foreign line railroads if necessary.

Warning to other movements is no longer necessary when:

- It is known adjacent tracks are not obstructed.
- or
- The train dispatcher or control operator advises the crew that protection is provided on adjacent tracks.

### Inspection of Cars and Units

- All cars, units, equipment, and track must be inspected as outlined in the:
  - Special Instructions.
  - Air Brake and Train Handling Rules.

#### **BNSF Amendment—The following is added:**

The following trains are relieved of visual inspection required by an emergency application when it is known that the brake pipe pressure has been restored by observing the caboose gauge, end-of-train telemetry device (ETD) or distributed power telemetry before proceeding:

- Solid loaded bulk commodity trains,
- Any train where emergency application of the brakes occurs at a speed above 30 MPH,
- or
- Any train that is 5000 tons or less.

If physical characteristics prevent a complete visual inspection, inspect as much of the train as possible. The train may then be moved, but may not exceed 5 MPH for the distance necessary to complete the inspection, and must be stopped immediately if excessive power is required to start or keep the train moving.

### Train on Adjacent Track

A train on an adjacent track that receives radio notification must pass the location specified at restricted speed and stop short of any portion of the stopped train fouling their track. When advised that the track is clear and it is safe to proceed, this restriction no longer applies.

## 6.24 Movement on Double Track

On double track, trains must keep to the right unless otherwise instructed.

## 6.25 Movement Against the Current of Traffic

Movements against the current of traffic must be authorized by track bulletin or track warrant, except as provided by:

- Rule 6.13 (Yard Limits).
- Rule 6.14 (Restricted Limits).
- Rule 9.15 (Track Permits).
- Rule 9.17.1 (Signal Protection in ABS by Lining Switch).

or

- Rule 16.1 (Authority to Enter DTC Limits).

Movements must approach block and interlocking signals prepared to stop unless signals indicate proceed.

When a facing point movement will be made over a spring switch, comply with Rule 8.9.1 (Testing Spring Switch).

## 6.26 Use of Multiple Main Tracks

Multiple main tracks will be designated by name or number. When necessary, track use will be indicated in the special instructions.

## 6.27 Movement at Restricted Speed

When required to move at restricted speed, movement must be made at a speed that allows stopping within half the range of vision short of:

- Train.
- Engine.
- Railroad car.
- Men or equipment fouling the track.
- Stop signal.

or

- Derail or switch lined improperly.

When a train or engine is required to move at restricted speed, the crew must keep a lookout for broken rail and not exceed 20 MPH.

Comply with these requirements until the leading wheels reach a point where movement at restricted speed is no longer required.

## 6.28 Movement on Other than Main Track

Except when moving on a main track or on a track where a block system is in effect, trains or engines must move at a speed that allows them to stop within half the range of vision short of:

- Train.
- Engine.
- Railroad car.
- Men or equipment fouling the track.
- Stop signal.

or

- Derail or switch lined improperly.

**6.28.1 Sidings of Assigned Direction**

Do not use sidings of an assigned direction in the opposite direction unless authorized by the train dispatcher.

**6.28.2 Stopping Clear in Siding**

When possible, a train entering a siding must not stop until the entire train is clear of the main track.

**6.28.3 Cars or Equipment Left on Siding**

Avoid leaving cars or equipment on sidings unless authorized by the train dispatcher, except in an emergency. In this case, notify the train dispatcher immediately.

**6.29 Inspecting Trains****6.29.1 Inspecting Passing Trains**

Employees must inspect passing trains. If they detect any of the following conditions, they must notify crew members on the passing train by any available means:

- Overheated journals.
- Sticking brakes.
- Sliding wheels.
- Wheels not properly positioned on the rail.
- Dragging equipment.
- Insecure contents.
- Signs of smoke or fire.
- Headlight or marker improperly displayed.
- Any other dangerous condition.

When possible, employees inspecting the passing train must advise crew members of the condition of their train.

When possible, a crew member on the engine of the train being inspected must notify a crew member on the rear of the train when the train is being inspected by other employees.

**Ground Inspections**

~~When a train is stopped and is met or passed by another train, crew members must inspect the passing train. The trainman's inspection must be made from the ground if there is a safe location. If safe to do so, a trainman must cross the track and inspect the side of the passing train opposite the stopped train.~~

**BNSF Amendment—The paragraph Ground Inspections is changed to read:**

When a train is stopped and is met or passed by another train, crew members must inspect the passing train. The trainman's inspection must be made from the ground if there is a safe location.

- Dismount equipment on the side opposite approaching train.
- Do not cross adjacent tracks solely for the purpose of inspecting a passing train.
- During inclement weather, crew members may remain in the locomotive cab when inspecting passing trains.

### **Trackside Warning Detectors and Inspections**

Crew members must be aware of trackside warning detectors and signals from persons inspecting their train. Stop the train immediately for an inspection when any of the following conditions exist:

- A crew member receives a stop signal.
- A trackside warning detector indicates a train defect.
- or
- A crew member is notified of a dangerous condition.

Movement must not proceed until it is safe.

## **6.29.2 Train Inspections by Crew Members**

When a walking inspection of the train is required, and physical characteristics prevent a complete train inspection, inspect as much of the train as possible. The train may then be moved, but may not exceed 5 MPH for the distance necessary to complete the inspection.

While their train is moving, crew members must inspect it frequently and look for indications of defects in the train, especially when rounding curves.

When inspecting their train, crew members must observe the train closely for any of the following:

- Overheated journals.
- Sticking brakes.
- Sliding wheels.
- Wheels not properly positioned on the rail.
- Dragging equipment.
- Insecure contents.
- Signs of smoke or fire.
- Any other dangerous condition.

Crew members who discover defects while the train is moving must stop the train promptly and correct any defects, if possible. If the defective car must be set out, they must not attempt to move the car to the setout point unless it is safe to do so.

When a car is set out because of an overheated journal, any fire must be completely extinguished and precautions taken to prevent further ignition.

## **6.30 Receiving or Discharging Passengers**

### **A. Passenger Crew Responsibilities**

When approaching a station to receive or discharge passengers, determine if the train is routed on the track nearest the station platform. If other trains could pass on a main track or controlled siding between the passenger train and the station platform:

- Communicate with the train dispatcher to determine whether any trains are approaching between the train and the station platform.
- Do not make the station stop until assured that trains will not pass between the train and the station platform.

If unable to communicate with the train dispatcher, the station stop may be made after the crew determines that no trains are approaching on the track between the train and the station platform. Before making the station stop, the conductor must assign crew member responsibilities to ensure passenger safety. If during the station stop a train is seen or heard approaching, crew members must take immediate action to keep passengers from fouling the affected track.

**B. Responsibilities of Approaching Movements**

When notified that a passenger train will be at a station, do not pass between station platform and a passenger train until assured that all passengers and employees have cleared the track between the passenger train and the station platform. Movement may then pass when preceded by an employee walking ahead of the movement.

**C. Other than Main Track Movements**

A movement must not pass between a passenger train and the station platform being used unless safeguards are provided.

**6.31 Maximum Authorized Speed**

Conductors and engineers are jointly responsible for knowing and not exceeding the maximum authorized speed for their train. Passenger speed is applicable only to trains consisting entirely of passenger equipment.

When possible, crew members must notify the train dispatcher promptly of any condition that will delay or prevent their train from making the usual speed.

**6.31.1 Permanent Speed Restrictions**

Permanent speed restrictions must not be exceeded until the rear of the train clears the limits of the restriction, unless otherwise specified.

**6.32 Road Crossings****6.32.1 Providing Warning Over Road Crossings**

When cars are shoved, kicked or a gravity switch move is made over road crossings at grade, an employee must be on the ground at the crossing to provide warning until crossing is occupied. Make any movement over the crossing only on the employee's signal.

Warning is not required when crossing is equipped with:

- Gates that are fully lowered.

or

- Flashing lights or passive warning devices when it is clearly seen that no traffic is approaching or stopped at the crossing. Shoving movements must not exceed 15 MPH over crossing until occupied.

**6.32.2 Automatic Warning Devices**

Under any of the following conditions, a movement must not foul a crossing equipped with automatic warning devices until the device has been operating long enough to provide warning and the crossing gates, if equipped, are fully lowered:

- Movement has stopped within 3,000 feet of the crossing.
- Movement is within 3,000 feet of the crossing and speed has increased by more than 5 MPH.
- Movement is closely following another movement.
- Movement is on other than the main track or siding.

or

- Movement enters a main track or siding within 3,000 feet of the crossing.

**Employees must observe all automatic warning devices and report any that are malfunctioning to the train dispatcher or proper authority by the first available means of communication. Notify all affected trains as soon as possible.**



**A. Automatic Warning Devices Malfunctioning**

Use the following table to properly complete movement over the crossing:

<b>Movement When Notified that Automatic Warning Devices have an Activation Failure, are Disabled or Malfunctioning</b>	
<b>If ...</b>	<b>Then ...</b>
The crew is notified that the crossing warning system has an activation failure or that the crossing warning system has been disabled and an equipped flagger is not at the crossing to provide warning.	Stop before occupying crossing. After a crew member is on the ground at the crossing to warn highway traffic, proceed over the crossing as directed by that crew member. Then proceed at normal speed.
The crew is notified that the crossing warning system is malfunctioning, and an equipped flagger is not at the crossing to provide warning.	Stop before occupying crossing. After a crew member is on the ground at the crossing to warn highway traffic, proceed over the crossing as directed by that crew member,  or  If devices are seen to be working or when instructed by the train dispatcher or proper authority, proceed with caution over the crossing at 15 MPH without stopping until the head end of the train completely occupies the crossing. Then proceed at normal speed.
The crew communicates with a flagger prior to fouling the crossing and receives confirmation that warning is being provided by at least one equipped flagger who is unable to provide warning in all directions of approaching traffic.	Proceed over the crossing at 15 MPH without stopping until the head end of the train completely occupies the crossing. Then proceed at normal speed.
The crew communicates with a flagger prior to fouling the crossing and receives confirmation that warning is being provided by one or more equipped flaggers who are able to provide warning in all directions of approaching traffic.	Proceed over the crossing at normal speed without stopping.
NOTE: An equipped flagger is a person other than a crew member who is equipped with an orange vest, orange shirt or orange jacket. At night, the vest, shirt or jacket must be fluorescent. The flagger must have a red flag or stop paddle by day and a light at night.	

When advised by the train dispatcher or proper authority that the automatic warning devices are repaired or returned to service, these restrictions no longer apply.

**B. Whistle for Crossing**

When notified that automatic warning devices are malfunctioning, sound whistle signal 5.8.2(7) regardless of any prohibition.

**BNSF Amendment—The following rule is added:**

**C. Power Off Indicators**

When the power off indicators on the side of signal housings at highway crossings are flashing or not illuminated, immediately notify the train dispatcher.

### 6.32.3 Providing Warning for Adjacent Tracks

When practical, position an employee on the ground to warn traffic against movements approaching on adjacent tracks, under either of the following conditions:

- A train or cut of cars is parted closer than 250 feet from a road crossing.
- The head-end of a train is stopped closer than 250 feet from a road crossing.

### 6.32.4 Clear of Crossings and Signal Circuits

Leave cars, engines, or equipment clear of road crossings and crossing signal circuits.

When practical, avoid leaving cars, engines, or equipment standing closer than 250 feet from the road crossing when there is an adjacent track.

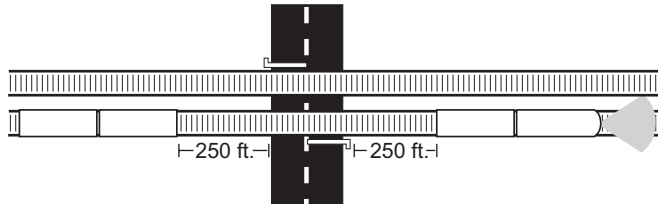

[Diagram A.]

### 6.32.5 Actuating Automatic Warning Devices Unnecessarily

Avoid actuating automatic warning devices unnecessarily by leaving switches open or permitting equipment to stand within the controlling circuit. If this cannot be avoided and if the signals are equipped for manual operation, a crew member must manually operate the signal for movement of traffic. A crew member must restore signals to automatic operation before a train or engine occupies the crossing or before it leaves the crossing.

### 6.32.6 Blocking Public Crossings

When practical, a standing train or switching movement must avoid blocking a public crossing longer than 10 minutes.

## 7.0 Switching

### 7.1 Switching Safely and Efficiently

While switching, employees must work safely and efficiently and avoid damage to contents of cars, equipment, structures, or other property.

Do not leave equipment standing where it will foul equipment on adjacent tracks or cause injury to employees riding on the side of a car or engine.

On tracks where clearance point is indicated, leave equipment beyond the clearance point.

If the clearance point is not indicated or visible, determine the clearance point by standing outside the rail of adjacent track and extend arm towards the equipment. When unable to touch the equipment, leave equipment at least an additional 50 feet into the track to ensure equipment is beyond the clearance point.

Equipment may be left on a:

- Main track, fouling a siding switch, when the switch is lined for the main track.
- Siding, fouling a main track switch, when the switch is lined for the siding.
- Yard switching lead, fouling a yard track switch when the switch is lined for the yard switching lead.
- or
- Industry track beyond the clearance point of the switch leading to the industry.

### 7.2 Communication Between Crews Switching

To avoid injury or damage where engines may be working at both ends of a track or tracks, crews switching must have a clear understanding of movements to be made.

### 7.3 Additional Switching Precautions

The following equipment must not be unnecessarily switched or couplings made so as to damage the equipment or load:

- Passenger or outfit cars.
- Intermodal or TOFC cars.
- Cabooses.
- Multi-level loads.
- Cars containing livestock.
- Open top loads subject to shifting.

The following equipment must not be cut off in motion or struck by any car moving under its own momentum:

- Passenger cars.
- Outfit cars.
- High-value loads.
- Engines.
- Loaded depressed-center flat cars.
- Cars loaded with modular housing units.
- Articulated and solid drawbar-connected cars with more than two car bodies. However, when empty, these cars may be kicked but not humped.
- Scale test cars.
- Roadway equipment.

## 7.4 Precautions for Coupling or Moving Cars or Engines

Before coupling to or moving cars or engines, verify that the cars or engines are properly secured and can be coupled and moved safely.

Make couplings at a speed of not more than 4 MPH. Stretch the slack to ensure that all couplings are made.

## 7.5 Testing Hand Brakes

Employees must know how to operate the type of brakes they are using. When hand brakes must control or prevent car movement, test the brakes to ensure that they are operating properly before using them.

## 7.6 Securing Cars or Engines

~~Do not depend on air brakes to hold a train, engine, or cars in place when left unattended. Apply a sufficient number of hand brakes to prevent movement. If hand brakes are not adequate, block the wheels.~~

**BNSF Amendment—The first paragraph is changed to read:**

Do not depend on air brakes to hold a train, engine or cars in place when left unattended. Engineer and conductor are jointly responsible, through job briefing, to ensure equipment left unattended is properly secured and a sufficient number of hand brakes are applied to prevent movement. If handbrakes are not adequate, block the wheels.

When the engine is coupled to a train or cars standing on a grade, do not release the hand brakes until the air brake system is fully charged.

When cars are moved from any track, apply enough hand brakes to prevent any remaining cars from moving.

## 7.7 Kicking or Dropping Cars

~~Kicking cars is permitted only when it will not endanger employees, equipment, or contents of cars.~~

~~Dropping cars is prohibited.~~

**BNSF Amendment—Entire rule is changed to read:**

Kicking cars is permitted only when it will not endanger employees, equipment or content of cars. Dropping cars is permitted only on territory where specifically authorized by individual subdivision special instructions.

Before dropping cars, crew members must fully understand the intended movement. They must verify that the track is sufficiently clear and that switches and hand brakes are in working order. If possible, the engine must run on straight track. Cars must not be dropped over spring switches or dual control switches.

### 7.7.1 Gravity Switch Moves

Unless otherwise restricted, a gravity switch move may be utilized where cars must be repositioned on the opposite end of the engine. Not more than five cars may be handled at one time.

When making a gravity switch move:

- Hand brakes must be tested to insure proper operation.
- Sufficient hand brakes must be manned by crew members to insure that the movement can be controlled and stopped.
- Using the hand brake on cars with shiftable loads must be avoided when practical.
- Cars must not be allowed to couple to other equipment.

## 7.8 Coupling or Moving Cars on Tracks Where Cars are Being Loaded or Unloaded

Before coupling to or moving cars on tracks where cars are being loaded or unloaded, crew members must be sure that all of the following have been removed or cleared:

- Persons in, on, or about cars.
- Platforms.
- Boards.
- Tank car couplings and connections.
- Conveyors.
- Loading or unloading spouts and similar appliances or connections.
- Vehicles.
- Other obstructions.

In addition:

- Be careful to avoid damage to freight of partly loaded cars.
- Do not handle cars that are improperly or unevenly loaded if load could shift or fall from the car, or if the car could derail or overturn.
- Return any car placed for loading or unloading to the location it was found if it has not been released for movement.
- Do not pull empty cars from an unloading facility until any major accumulation of debris is removed.
- Ensure that plug-type and swinging doors on cars are properly closed or secured. However, crew members must not attempt to close those doors. If plug door is found open enroute, car may continue in the train to the next location where mechanical forces are available to close door.

## 7.9 Switching Passenger or Occupied Outfit Cars

Before switching passenger equipment or occupied outfit cars:

- Couple the air hoses.
- Fully charge the brake system.
- Use the automatic brake valve when switching.

When coupling passenger or outfit cars:

- Stop the movement approximately 50 feet before the coupling is made.
- Have an employee on the ground direct the coupling.
- Ensure couplers are fully compressed and stretched to ensure that knuckles are locked before making:
  - Air connections
  - Steam connections
  - Electrical connections

## 7.10 Movement Through Gates or Doorways

Before moving engines, cars, or other equipment through gates, doorways, or similar openings, stop to ensure that the gates, doorways, or openings are completely open and secure. When overhead or side clearances are close, make sure movement is safe. ~~Do not ride on side of a car, engine or other equipment when moving through gates, doorways or similar openings.~~

**BNSF Amendment—The last sentence is changed to read:**

Do not ride on side of a car, engine or other equipment when moving through gates, doorways or similar openings where close clearance exists.

## 7.11 Charging Necessary Air Brakes

Do not handle cars without charging the air brake system, unless the cars can be handled safely and stopped within the required distance. If necessary, couple the air hoses and charge the brake systems on a sufficient number of cars to control movement.

## 7.12 Movements Into Spur Tracks

When shoving cars into a spur track, control movement to prevent damage at the end of the track, and do the following:

- Stop movement 150 feet from the end of the track.
- Apply hand brakes, when necessary, to control slack.
- Have a crew member precede any further movement when it can be done safely.
- Move only on the crew member's signal.

## 7.13 Protection of Employees in Bowl Tracks

During humping operations, before a train or yard crew member goes between engines or cars on a bowl track to couple air hoses or adjust coupling devices, or before an employee performs maintenance on a bowl track, protection must be provided against cars released from the hump into the track as follows:

- The employee requesting protection must notify the employee controlling the switches that provide access from the hump to the track where the work will occur.
- After being notified, the switch controller must line any remote control switch against movement to the affected bowl track and apply a locking or blocking device to the control for that switch.
- The switch controller must then notify the employee that protection is provided. Protection will be maintained until the switch controller is advised that work is complete and protection is no longer required.

## 8.0 Switches

### 8.1 Hand Operation of Switches

Spring or dual control switches operated by hand are considered hand-operated switches, and all rules governing hand-operated switches apply.

### 8.2 Position of Switches

The employee handling the switch or derail is responsible for the position of the switch or derail in use. The employee must not allow movement to foul an adjacent track until the hand-operated switch is properly lined.

Do not operate switch that is tagged. If the switch is spiked, do not remove the spike unless authorized by the same craft or group that placed it.

Employees handling switches and derails must make sure:

- The switches and derails are properly lined for the intended route.
- The points fit properly and the target, if so equipped, corresponds with the switch's position.
- When the operating lever is equipped with a latch, they do not step on the latch to release the lever except when throwing the switch.
- After locking a switch or derail, they test the lock to ensure it is secured.
- The switch is not operated while equipment is fouling, standing on, or moving over the switch.
- When equipment has entered a track, the switch to that track is not lined away until the equipment has passed the clearance point of the track.

When possible, crew members on the engine must see that the switches and derails near the engine are properly lined.

### 8.3 Main Track Switches

The normal position of a main track switch is for main track movement, and it must be lined and locked in that position. At points where double track begins, the normal position of a spring switch is for movement with the current of traffic.

However, the main track switch may be left open:

- In CTC territory within track and time limits.
- When attended by a crew member or switch tender.
- During switching operations when it is certain that no other train or engine will pass over the switch.
- For another train or engine when the switch is attended by a member of that crew.
- Within ABS limits when instructed by the train dispatcher at:
  - The entering switch of a siding in Rule 9.14 (Movement with the Current of Traffic) territory.
  - Either switch of a siding in Rule 16.1 (Authority to Enter DTC Limits) territory.

- Within TWC territory when authorized by track warrant. Track warrant protection must be provided for this condition. The switch must not be considered restored to normal position until the train dispatcher is notified by an employee or train at that location.

or

- Within ABS-TWC, ABS-DTC, or Rule 9.14 (Movement with the Current of Traffic) territory at the entering switch of a siding after the following has been done:
  1. Communication has been established between crews of trains meeting or passing.
  2. An understanding has been reached that the train on the main track will stop and restore the switch to the normal position. A crew member must not report clear of the limits until it is known the switch is lined and locked in the normal position.

On main track switches (if equipped), the target will be red if the switch is lined in other than its normal position.

Before leaving the location where a hand-operated main track switch was operated:

- Crew members must confirm the position of the switch with each other.
- Engineering Department employees granted authority to enter working limits must confirm the position of the switch with the employee in charge or a designated employee who will notify the employee in charge.

## 8.4 Lining Main Track Switch

When an employee lines the switch to let a train enter or leave the main track, the employee must then go to the opposite side of the main track and not return to the switch stand until movement is complete. If unable to go to the opposite side of the track, the employee must stand at least 20 feet from the switch stand.

## 8.5 Clearing Main Track Before Restoring Switch

Do not return a main track switch to the normal position until movement is clear of the main track.

## 8.6 Restoring Switch to Normal Position

An employee getting off moving equipment to return the main track switch to normal position must, when possible, get off the equipment on the opposite side from the switch stand.

## 8.7 Clear of Main Track Switches

Except in switching movements, when a train or engine is approaching or passing on a main track, employees must not go nearer than 20 feet to any main track switch.

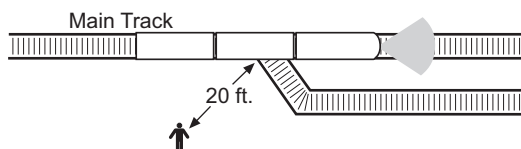

[Diagram A.]

When a train or engine that will be met or passed is on a siding or other track, the employee attending the switch must be in a safe location. The employee must not be nearer than 150 feet, if possible, from the switch when the train is closely approaching and passing.

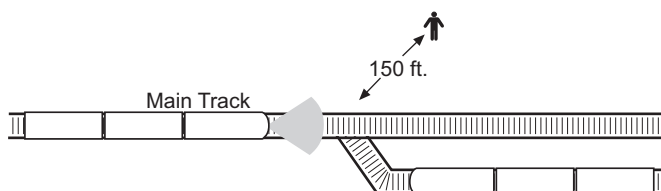

[Diagram B.]



### Inspecting Hand-Operated Switches in Non-Signaled Territory

In non-signaled territory, if the expected train is not closely approaching, a crew member will inspect facing point, hand-operated switches the train will pass over to determine that the:

- Switches are lined for the intended route.
- Switch points fit properly.
- Switch lever is secured.

## 8.8 Switches Equipped with Locks, Hooks or Latches

When not in use, switches must be locked, hooked, or latched if so equipped. Before making movements in either direction over these switches, make sure the switch is latched or secured by placing the lock or hook in the hasp. However, when making train movements in facing point direction, lock the switches equipped with a lock.

Replace any missing or defective switch locks. If they cannot be replaced, report the condition at once to the train dispatcher, yardmaster, or supervisor in charge, and spike the switch if possible.

## 8.9 Movement Over Spring Switches

Spring switches are identified by the letters S or SS, special targets, signs, and/or lights.

### 8.9.1 Testing Spring Switch

A crew member tests the switch by lining the switch over and back by hand and examining the switch points to see that they fit properly.

Before a train or engine makes a facing point movement over a spring switch, the switch must be tested when any of the following conditions exist:

1. A block signal governing movement over the switch indicates:
  - Stop.
  - Stop and Proceed.

or

  - Restricted Proceed.

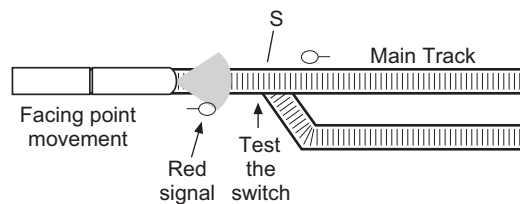

[Diagram A.]

2. A switch point indicator protecting the switch indicates Stop and Inspect Switch.
- or
3. The switch is not protected by a block signal or switch point indicator.

The switch does not need to be tested if it has been lined for the diverging route or written instructions advise the crew that the spring switch has been spiked.

### 8.9.2 Trailing Through and Stopping on a Spring Switch

A train or engine trailing through and stopping on a spring switch must control the slack. A crew member must line the switch by hand before the train or engine can change direction or take slack.

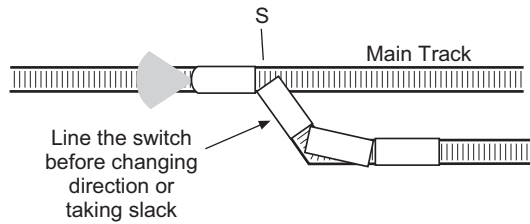

[Diagram A.]

### 8.9.3 Hand Operating a Spring Switch Before Making a Trailing Movement

#### A. With Facing Point Lock

When a train is stopped by a signal governing trailing movement through a spring switch and the switch is equipped with a facing point lock, operate the switch by hand. Do not return the switch to normal position until after movement is complete.

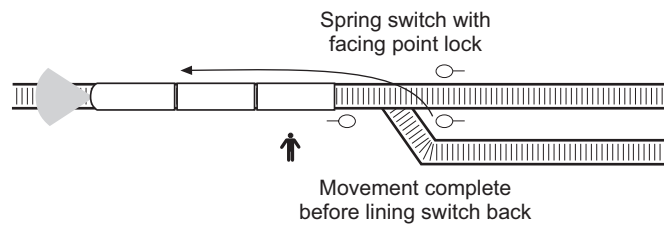

[Diagram A.]

#### B. Without Facing Point Lock

Before a train makes a trailing movement through a spring switch not equipped with a facing point lock, and only hand operation can establish block signal protection, line the switch for the intended route. Return the switch to normal position after leading wheels have passed both insulated joints.

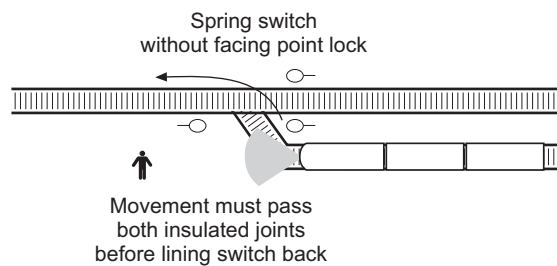

[Diagram B.]

**8.9.4 During Snow or Ice Storms**

During snow storms, ice storms, or other conditions that may prevent a spring switch from functioning properly, avoid making a trailing movement through the spring switch until the switch has been lined by hand for the movement.

**8.9.5 Spiking Spring Switch**

A spring switch that is spiked must be protected.

**8.9.6 Approaching a Spring Switch in Non-Signaled Territory**

A train in non-signaled territory must approach the facing points of a spring switch prepared to stop until:

- A switch point indicator shows that the switch is properly lined.
- or
- A distant signal displays clear.

**8.10 Switch Point Indicator**

Aspect	Indication
Green.....	Switch points fit properly in normal position.
Yellow.....	Switch points fit properly in reverse position.
Red or Dark.....	Stop and inspect switch.

**8.11 Switches in Sidings**

The normal position of switches connecting any track, except the main track, to a siding is lined and locked or secured for movement on the siding.

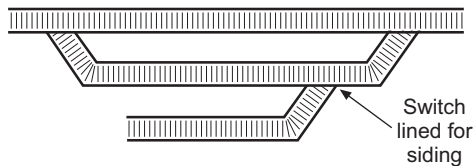

[Diagram A.]

**8.12 Hand-Operated Crossover Switches**

The normal position of crossover switches is for other than crossover movement. The crossover switches must be left lined in normal position, except when they are in use for crossover movements. Both switches of a crossover shall be properly lined before equipment begins a crossover movement. A crossover movement shall be completed before either switch is restored to normal position, except when one crew is using both tracks connected by the crossover during continuous switching operations.

In Rule 6.14 (Restricted Limits), Rule 6.28 (Movement on Other than Main Track) or non-signaled Rule 6.13 (Yard Limits) territory, crossover switches may be left out of correspondence while providing blue signal or inaccessible track protection. When protection is no longer required the crossover switches connected to a main track or siding must be left lined for other than crossover movement. Crossover switches not connected to a main track or siding must be left in a corresponding position.

In signaled territory, crossover switches may be out of correspondence while performing maintenance, testing or inspection.

### 8.13 Scale Track Switches

When scales are not in use, line switches for dead rails where provided.

### 8.14 Conflicting Movements Approaching Switch

When conflicting movement is closely approaching a switch, the track must not be fouled or the switch operated. Except at a spring switch, trains must not foul a main track or signaled track or pass beyond an insulated joint at the clearance point until the switch connected with the movement is properly lined.

Crossover switches must not be unlocked or lined for crossover movement when another movement is approaching or passing over either switch.

### 8.15 Switches Run Through

Do not run through switches, other than spring switches or variable switches. If a rigid type switch is run through, it is unsafe and must be protected by spiking the switch, unless a trackman or other employee takes charge.

An engine or car that partially runs through a switch must continue movement over the switch. The engine or car must not change direction over a damaged switch until it has been spiked or repaired.

### 8.16 Damaged or Defective Switches

Report a switch that is damaged or defective to the train dispatcher, yardmaster, or supervisor in charge. Tag the switch, spike it if necessary, unless trackman or other employee takes charge. If the switch cannot be made safe, provide protection at once.

### 8.17 Avoid Sanding Over Moveable Parts

When possible, avoid using sand over moveable parts of an interlocking, retarders, spring switches, variable switches, or power-operated switches.

### 8.18 Variable Switches

Trailing point movements may be made over a variable switch from either track, regardless of the position of the switch points.

When making a trailing point movement and the switch is not lined for such movement, make sure all wheels of the leading car or unit clear the switch points before changing direction.

During snow storms, ice storms, or other conditions that may prevent a variable switch from functioning properly, avoid making a trailing point movement through a variable switch until it has been lined by hand for movement.

### 8.19 Automatic Switches

The location of automatic switches will be designated in the timetable. When movement authority requires a train to stop at an Automatic Switch location, stop must be made before any part of a train passes the signal governing movement over the Automatic Switch. To operate an automatic switch to enter the siding, a crew member must do the following:

- Stop the leading end of movement within 200 feet of the absolute signal that governs movement over the switch.
- Operate the push button on the signal mast.

After 40 seconds, the signal will display a restricting indication when the switch is lined for movement into the siding.

When the signal that governs movement over an automatic switch displays a Stop indication, the switch must be operated by hand before proceeding.

### Operating an Automatic Switch by Hand

To operate an automatic switch by hand, the crew member must stop the train for the signal that governs movement over the switch and then do the following:

- Unlock the switch lock.
- Place the selector lever in the HAND position.
- Operate the hand throw lever until the switch points move when the lever is moved.
- Line the switch for the intended route.
- Do not return the selector lever to the POWER position until at least one unit or car has passed over the switch.

After switch is placed in hand position, signal governing movement over the switch will display Stop indication and movements will be governed by hand signals.

When the switch is returned to the POWER position and movement over the switch is complete, the switch will automatically return to its normal position.

**Entering Main Track.** A train that is about to enter the main track and is authorized to proceed must move past the overlap sign. Further movement must not be made until the signal governing movement over the switch displays a proceed indication. If the signal does not display a proceed indication within 5 minutes, a crew member must operate the switch by hand as specified in Rule 9.17 (Entering Main Track at Hand- Operated or Spring Switch), waiting an additional 5 minutes, if necessary.

**When automatic switches are operated by hand, all rules governing hand-operated switches apply, except cars must not be dropped over the switches.**

#### **BNSF Amendment—The following paragraph is added:**

In non-signaled territory, when movement continues beyond an automatic switch signal displaying a Stop indication, train must move at restricted speed for two miles or until leading wheels pass the next automatic switch signal or opposing distant signal.

### 8.19.1 Radio Controlled Switches

The location of radio controlled switches and operating instructions will be designated in the timetable and special instructions.

## 8.20 Derail Location and Position

Employees in train, engine, and yard service must know the location of all fixed derails. A train or engine moving on or entering tracks where fixed derails are located, must stop at least 100 feet from derail in derailing position. Movement must not continue until the derail is placed in the non-derailing position. However, the distance restriction will not apply in engine servicing areas.

Do not make a movement over a derail in derailing position.

Sidings having hand-thrown derails will have derail locked in non-derailing position, except when engines or cars are left unattended on siding. On auxiliary tracks other than siding, except when derails are placed in non-derailing position to permit movement, make sure they are always in derailing position regardless of whether cars are on the track they are protecting. Lock all derails equipped with a lock.

Derails that are used in conjunction with Rule 5.12 (Protection of Occupied Outfit Cars), Rule 5.13 (Blue Signal Protection of Workmen), or roadway worker protection must be in the derailing position only when their use is required for such protection. When their use is not required for protection:

- Remove portable derails.
- or
- Lock fixed derails in non-derailing position with an effective locking device.

**This page left blank intentionally.**

## 9.0 Block System Rules

### 9.1 Signal Aspects and Indications

Distant, block, and interlocking signal aspects and indications are shown in the special instructions.

Signal aspects are identified by the position of semaphore arms, color of lights, flashing of lights, position of lights, or any combination. Aspects may be qualified by marker plate, number plate, letter plate, or marker light.

Signals may display color light aspects or semaphore arms and color lights.

### 9.2 Location of Signals

When viewed from the train, block and interlocking signals are generally to the right of the track. However, they may be located to the left or above the track. To display indications for two tracks, two bracketed signals may be located on a supporting mast. The signal to the right governs the track to the right, and the signal to the left governs the track to the left.

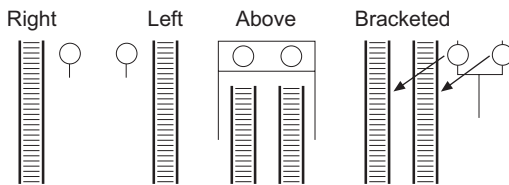

[Diagram A.]

### 9.3 What Signals Govern

Block signals, cab signals, or both govern the use of blocks.

Interlocking signals govern the use of interlocking routes. Where a track is signaled beyond the interlocking limits in the direction of movement, the interlocking signal is also a block signal.

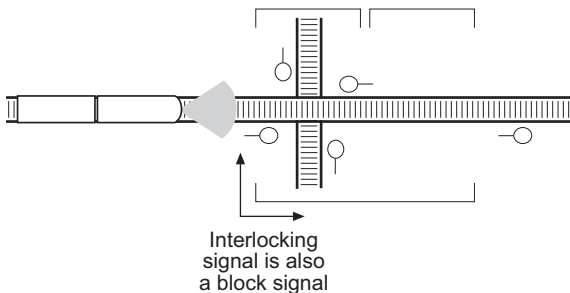

[Diagram A.]

All other rules, where required, remain in effect when complying with the indication of block and interlocking signals.

### 9.4 Improperly Displayed Signals or Absent Lights

Except as shown in block, cab, and interlocking signal aspects in the special instructions, if a light is absent, a white light is displayed where a colored or lunar light should be, or additional colored or lunar lights are displayed, regard a block or interlocking signal as displaying the most restrictive indication it can give. However, when the semaphore arm position is plainly seen, that aspect will govern.

## 9.5 Where Stop Must Be Made

When movement is being made beyond a block signal requiring a train to be prepared to stop at the next signal, the stop must be made before any part of a train passes the block signal requiring the train to stop.

If a train overruns any block signal that requires it to stop, the crew must:

- Warn other trains at once by radio.
- Stop the train immediately.
- Report it to the train dispatcher.

### 9.5.1 Changing Established Route

Except to avoid an accident, after a controlled signal has been cleared for a closely approaching train, the control operator must not change the signal before the approaching train's engineer has assured the control operator that he can comply with the signal change. Do not establish or authorize a conflicting route until communicating with the approaching train's crew and ensuring that the train has stopped clear of the conflicting route.

The control operator must not establish a conflicting route into an occupied block or interlocking limits, or authorize a conflicting movement, unless it is safe to do so.

The control operator must avoid operating the device controlling a switch, derail, movable point frog, or lock when any portion of a train is on or closely approaching the equipment.

### 9.5.2 Protection if Signal Appliance or Track is Damaged

If a signal or signal appliance functions improperly or the track is damaged, signals that govern movements on affected routes must display a Stop indication. No movements on such routes may be permitted until track and signal appliances are examined and movement can occur safely.

### 9.5.3 Protection During Repairs

Within CTC limits or within manual interlocking limits (unless track bulletin Form B is in effect), when a switch, movable point frog, derail, or signal is under repair or is disconnected, or when the track is obstructed or removed from service, display Stop indications for all affected routes. In addition, block or mark any controls to prevent their operation.

Maintenance forces must contact the control operator before beginning repairs, disconnecting equipment, obstructing the track, or removing the track from service. Switches, movable point frogs, and derails must be spiked or secured in the required position if any movement over them occurs before repairs are complete.

### 9.5.4 Authority to Proceed

Except when a signal is used to provide protection within CTC limits or at manual interlockings, control operators must not give hand signals or verbally authorize movement beyond a Stop indication when a proceed indication can be displayed for the movement.

At manual interlockings, control operators must give hand signals so that crew members can understand the signals and know which train they are intended for.

### 9.5.5 Reporting Delays

When a controlled signal displays a proceed indication, notify the control operator immediately if movement cannot occur promptly.



### 9.5.6 Track Occupancy Indicator

Where track occupancy indicators are located, employees must observe the indication before fouling a circuit or changing the derail or a main track switch.

When an occupied indication is displayed, trains or equipment must not foul the main track unless movement is properly protected.

Track occupancy indications do not authorize movement or relieve employees from protecting movements as required by the rules.

## 9.6 Change of Signal Indication

If a signal displaying a proceed indication changes to an indication requiring a train to stop, the train must stop at once. Report such a signal change to the train dispatcher.

## 9.7 Failure to Display Most Restrictive Indication

When a block is occupied, or when a switch protected by a signal is changed from its normal position and that signal fails to display its most restrictive indication, regard the signal as displaying Stop. The train must stop immediately, and employees must warn others by radio of the exact location and status of the train. Contact the train dispatcher or control operator and do not move the train without permission.

## 9.8 Next Governing Signal

A train may comply with the next signal's indication when its aspect can be clearly seen and the signal governs the track where movement is occurring or will be made. This does not apply when a rule or previous signal indication requires movement at restricted speed.

## 9.9 Train Delayed Within a Block

If a train has entered a block on a proceed indication that does not require restricted speed, and the train stops or its speed is reduced below 10 MPH, the train must:

### A. ABS

Proceed at restricted speed. The train must maintain this speed until the next signal is visible, that signal displays a proceed indication, and the track to that signal is clear.

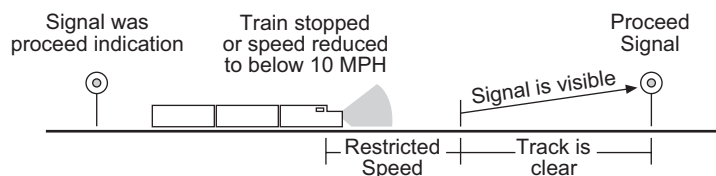

[Diagram A.]

### B. CTC or Manual Interlocking Limits

Proceed prepared to stop at the next signal until the next signal is visible and that signal displays a proceed indication.

### C. ACS

Operate according to cab signal indication.

### 9.9.1 Approach to Automatic Interlocking

A train must proceed prepared to stop at the interlocking signal when:

- Moving below 25 MPH and passing a signal that governs the approach to an automatic interlocking.
- or
- Speed is reduced below 25 MPH after passing a signal that governs the approach to an automatic interlocking.

The train must continue to move prepared to stop at the interlocking signal until the train reaches a point approximately 1,000 feet from that signal. If the interlocking signal then indicates proceed, the train may resume speed.

## 9.10 Initiating Movement Between Signals

When one of the following occurs, move at restricted speed until the leading wheels have passed the next governing signal or the end of the block system:

- The train enters a block with no governing signal.

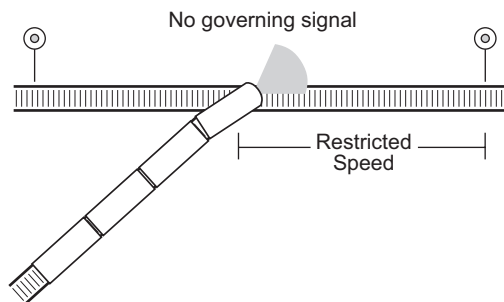

[Diagram A.]

- The previous signal indication is unknown.
- Movements in the opposite direction from which the block was entered.

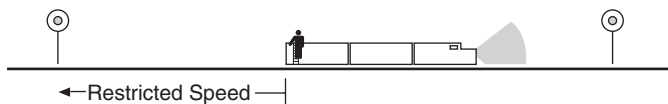

[Diagram B.]

#### Exception

If a train is within ACS or ATC territory with operative cab signals, the train may operate according to the cab signal indication.

## 9.11 Movement from Signal Requiring Restricted Speed

When a train passes a signal requiring movement at restricted speed, the train must move at restricted speed until its leading wheels have passed the next governing signal or the end of the block system.

#### **BNSF Amendment—Entire rule is changed to read:**

When a train passes a signal requiring movement at restricted speed, the train must move at restricted speed until its leading wheels have passed the next governing signal. When leaving block system limits, trains operating on the main track must move at restricted speed for two miles or until leading wheels pass the opposing distant signal.

## 9.12 Stop Indications

### 9.12.1 CTC Territory

At a signal displaying a Stop indication, if no conflicting movement is evident, the train will be governed as follows:

- A crew member must immediately contact the control operator, unless the train is:
  - Within track and time limits
  - or
  - Entering track and time limits from any point other than either end of track and time limits.
- Before authorizing the train to proceed, the control operator must know that the route is properly lined and no conflicting movement is occupying or authorized to enter the track between that signal and the next absolute signal governing movement or the end of CTC where applicable.
- When the train receives these instructions, “After stopping, (train) at (location) has authority to pass signal displaying Stop indication,” specifying the route where applicable. The train must move at restricted speed.

#### Exception

**Conflicting Movement.** When the control operator has stopped a conflicting movement, he may then authorize another train to proceed in the same limits, advising both crews of movement to be made. If the stopped movement is later permitted to proceed, that train must move at restricted speed until its leading wheels have passed the next governing signal or the end of the block system.

### 9.12.2 Manual Interlockings

At a signal displaying a Stop indication, if no conflicting movement is evident, the train will be governed as follows:

- A crew member must immediately contact the control operator.
- Before authorizing the train to proceed, the control operator must know that the route is properly lined and no conflicting movement is occupying or authorized to enter the track between that signal and the next absolute signal governing movement or the end of interlocking limits where applicable.
- The control operator may authorize the train to proceed using hand signals or the following instructions, “After stopping, (train) at (location) has authority to pass signal displaying Stop indication,” specifying the route where applicable. The train must move at restricted speed.
- If the signal governs movement over a drawbridge, a crew member must verify that the bridge is in the proper position for the train to pass.

Before proceeding into or continuing in CTC territory, the manual interlocking control operator must be sure that the CTC control operator has given authority to proceed.

#### Exception

**Conflicting Movement.** When the control operator has stopped a conflicting movement, he may then authorize another train to proceed, advising both crews of movements to be made. If the stopped movement is later permitted to proceed, that train must move at restricted speed until its leading wheels have passed the next governing signal or the end of the block system.

### 9.12.3 Automatic Interlockings

At a signal displaying a Stop indication, the crew will be governed by instructions in the release box, special instructions, or other instructions. After complying with the instructions that allow the train to proceed, if signal continues to display a Stop indication, the train must move at restricted speed. However, if there is a conflicting movement, the train must not proceed until the movement has passed or stopped, and both crews agree on the next movement.

### 9.12.4 ABS Territory

At a signal displaying a Stop indication outside interlocking limits, the train will be governed as follows:

#### A. Main Track

On a main track, except where Rule 9.14 (Movement with the Current of Traffic) is in effect, after stopping, a train authorized beyond the signal must comply with one of the following procedures:

1. Proceed at restricted speed, if authority beyond the signal is joint with other trains or employees.
2. Proceed at restricted speed to permit an engine, with or without cars, to couple to its train or to a standing cut of cars, if the track between the engine and cars is clear.
3. Proceed at restricted speed when a crew member has contacted the train dispatcher and obtained permission to pass the Stop indication. However, if the train dispatcher cannot be contacted, move 100 feet past the signal, wait 5 minutes, then proceed at restricted speed.

#### B. Movement with the Current of Traffic

On a main track where Rule 9.14 (Movement with the Current of Traffic) is in effect, after stopping, a crew member must contact the train dispatcher or control operator and obtain permission to pass the Stop indication, then proceed at restricted speed. However, if the signal governs movement to a single main track, comply with Rule 9.17 (Entering Main Track at Hand-Operated or Spring Switch), then proceed at restricted speed.

#### C. Siding or Other Track

If the signal governs movements from a siding or other track to the main track, comply with Rule 9.17 (Entering Main Track at Hand-Operated or Spring Switch), then proceed at restricted speed.

## 9.13 When Instructed to Operate Dual Control Switches by Hand

If the control operator cannot line the dual control switch to the desired position, or the control machine does not indicate that the switch is lined and locked, the control operator must authorize movement past the Stop indication and instruct the employee to operate the switch by hand. Movement may then proceed to that switch.

Before passing over the switch, the train must stop and the employee must operate the switch by hand as outlined in Rule 9.13.1 (Hand Operation of Dual Control Switches). After at least one unit or car has passed over the switch points, the employee must return the switch to power unless otherwise instructed by the control operator.

### 9.13.1 Hand Operation of Dual Control Switches

An employee must get permission from the control operator to operate a dual control switch by hand. Operate the switch as follows:

- Unlock the switch lock.
- Place the selector lever in the HAND position or remove the hand crank from the holder.
- Operate the hand throw lever until the switch points are seen to move when the lever is operated, even if the switch is lined for the intended route.
- Line the switch for the intended route, or insert the crank on the shaft and turn the crank as far as it will turn until the switch is in the desired position. Remove the crank from the shaft, but do not return it to the crank holder.
- Return the switch to power by restoring the selector lever to the POWER or MOTOR position and lock. Or, return the crank to the holder and secure it with the switch lock. Notify the control operator after power to the switch is restored.

When the selector lever is in the HAND position or the crank has been removed from the holder, signals governing movements over the switch will display Stop indication, and movements will be governed by hand signals. Notify the engineer, if possible, when the switch is in hand operation and when it has been restored to power operation.

For other types of switch machines, follow the above procedure using the instructions for operation posted at the switch or by special instructions.

## 9.14 Movement with the Current of Traffic

On tracks designated in the timetable, trains will run with the current of traffic, if the train dispatcher gives verbal authorization or a controlled signal indicates proceed.

### 9.14.1 Reporting Clear of a Track Having a Current of Traffic

A train without a crew member on the rear and operating on a track having a current of traffic may report clear of the limits or report having passed a specific location only when it is known the train is complete. This must be determined by one of the following ways:

- The rear of the train has a rear-end telemetry device, and air pressure on the head-end device indicates brake pipe continuity.
- An employee verifies the marker is on the rear of the train.
- A crew member can observe the rear car of the train on which the marker is placed.
- The train is stopped and an inspection verifies that the marker is on the rear car of the train.
- A trackside warning detector transmits an axle count for the train, and axle count duplicates the axle count transmitted by the previous trackside warning detector.

In addition, a train clearing in a siding or other track must comply with requirements outlined in Rule 8.3 (Main Track Switches) before reporting clear of the limits.

## 9.15 Track Permits

On tracks designated in the timetable, a track permit will authorize a train, track car, machine, or employee to occupy the main track or tracks between specific points. The track permit must be issued by a designated control operator under the direction of the train dispatcher. Within these limits, movements may be made in either direction according to signal indication.

Limits designated by a switch extend only to the signal governing movement over the switch, unless otherwise designated.

A train must obtain authority to pass a controlled signal displaying Stop indication to enter track permit limits. Within track permit limits a train, after stopping, may pass a signal displaying Stop indication at restricted speed without further authority, except when signal governs movement at an interlocking.

### 9.15.1 Issuing Track Permits

The track permit may only be issued when:

- Limits are clear.
  - Limits are occupied by the train, track car, machine, or employee who will receive the track permit.
  - Limits are occupied by a train, track car, machine, or employee holding a track permit.
- or
- All trains moving on signal indication without a track permit have passed the location where the track will be fouled.

The track permit limits must be protected by controlled signals. The designated control operator must know the following before issuing a track permit:

- Each controlled signal protecting the limits displays a Stop indication.
- Marking or blocking devices prevent displaying signals for movement into the limits.
- The designated control operator and each control operator who controls signals to protect the limits understand the limits, have provided protection, and have recorded the track permit on the prescribed form.

#### Track Permit Acknowledgment

Track permit authority must be recorded and repeated to the control operator. Acknowledgment must be received before being acted upon.

The control operator must maintain a record of the authority granted.

#### More than One Track Permit

If more than one track permit is in effect at any time within the same limits, all affected trains or employees must be notified.

Trains must move at restricted speed within these limits.

### 9.15.2 Clearing Track Permits

Marking or blocking devices must not be changed or removed until the limits have been released to the control operator.

Track permit limits must be cleared and reported clear to the control operator before time expires. If the track permit is released before time expires, all equipment must be clear of the limits and reported clear to the designated control operator. However, if no other track permit has been granted within the same limits, the train may request release of the track permit. Signal indications will then govern the train if the control operator verbally authorizes the release, specifying direction of movement if required.

When necessary to modify the expiration time, an employee and the control operator must communicate before the time expires to adjust the time granted. If the employee cannot contact the control operator and the time limit expires, authority is extended until the control operator is contacted.

Employees reporting clear of track permit authority must state:

- Their name or other identification.
- Track permit number being released.
- Limits being released.

**BNSF Amendment—The following 4th bullet is added:**

- Position of hand operated main track switches.

**Releasing Portion of Limits**

When a crew member informs the control operator that the authority is released between two specific points, the authority is considered void between those points. This track release must begin at the outer limit of the authority.

## 9.16 Stop and Proceed Indication

At a signal displaying a Stop and Proceed indication, the train will be governed as follows:

1. The train must stop, then proceed at restricted speed.  
or
2. The train may pass the signal at restricted speed without stopping to do any of the following:
  - a. Leave the main track when the switch is lined for movement and the track is clear from the signal to the clearance point.

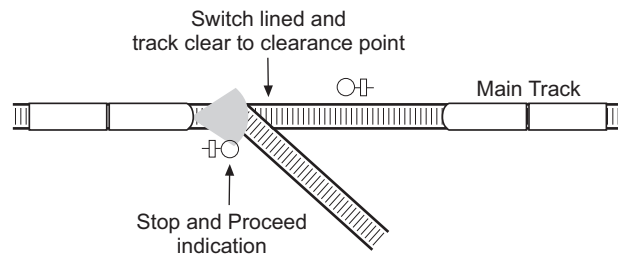

[Diagram A.]

- b. Continue on the main track when meeting or passing a train, and the main track is clear to the opposite end of the siding where a train is fouling the main track.

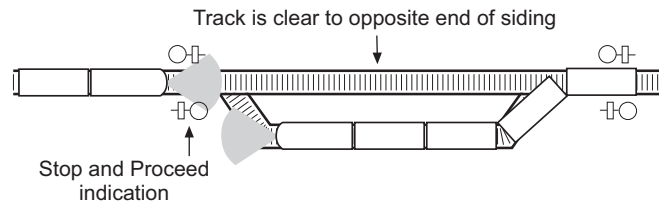

[Diagram B.]

- c. Permit an engine, with or without cars, to couple to its train or to a standing cut of cars, if the track between the engine and cars is clear.

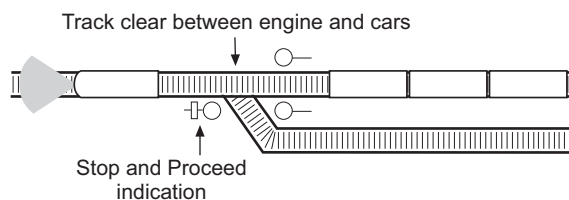

[Diagram C.]

- d. Enter a switch that is less than 1,000 feet beyond the signal, and the employee in charge of the switch has granted permission for movement.

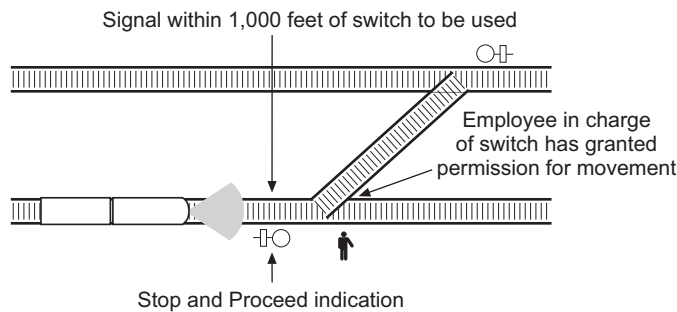

[Diagram D.]

- e. ~~Continue on the main track when proceeding at restricted speed due to rule or previous signal indication.~~

**BNSF Amendment—Paragraph 2.e. is changed to read:**

- e. Proceed from a Stop indication in CTC territory, when authorized by the control operator as prescribed in Rule 9.12.1 (CTC Territory). This will apply to each consecutive signal displaying a Stop and Proceed indication.

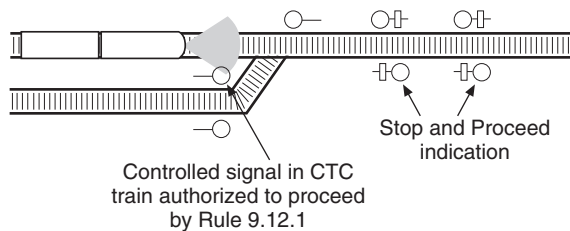

[Diagram E.]

- f. Move within track and time, work and time, work between, track permit, or track out of service limits.

## 9.17 Entering Signaled Track at Hand-Operated or Spring Switch

Within CTC territory and manual interlocking limits, the control operator must authorize the train to enter the track at a hand-operated or spring switch where no governing signal exists. The control operator must verify that there are no conflicting movements before giving the authority.

In ABS territory, when authorized to enter the signaled track, a crew member or switch tender must open the switch and wait 5 minutes at the switch to establish block signal protection. If at the end of 5 minutes the employee does not hear or see movement approaching, the train may enter the signaled track. At a crossover, line the switch in the track the train is on, wait the 5 minutes, then line the other switch of the crossover.

### A. When Hand Operation of a Spring Switch or 5-Minute Wait is Not Required

Waiting 5 minutes or operating the spring switch by hand is not required [unless prescribed by Rule 8.9 (Movement over Spring Switches)] under any of the following conditions:

1. Switch is equipped with an electric lock.
2. Track occupancy indicator indicates track is clear.



3. Block signal governing movement to signaled track indicates proceed.
4. Block signals governing movements on the signaled track indicate that no train is approaching from either direction.

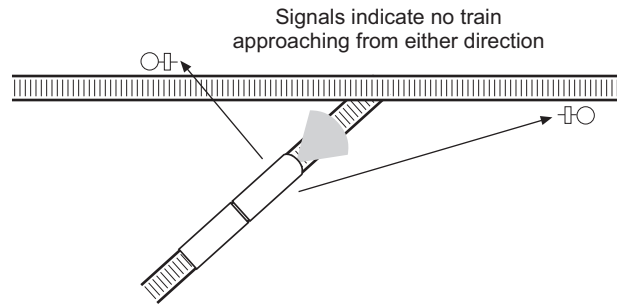

[Diagram A.]

5. Block to be entered is occupied by a train, engine, or car that is standing or moving away from the switch to be used.

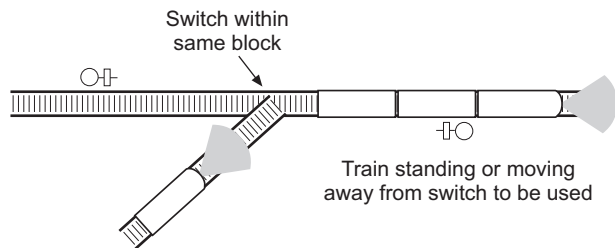

[Diagram B.]

6. Main track between siding switches is occupied by a train that has been met or a standing train that will be passed.

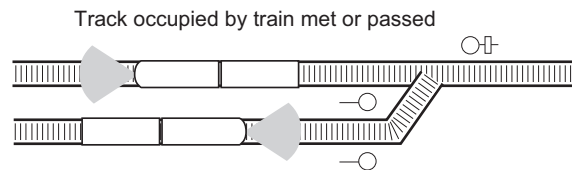

[Diagram C.]

7. Train is entering a main track outside of yard limits for authorized movement against the current of traffic.
8. Rule 6.14 (Restricted Limits) is in effect, provided movement does not occur beyond restricted limits for 5 minutes after the main track circuit is fouled, unless a block signal displays a proceed indication.
9. Work and time authority is granted within DTC.
10. Track permit authorizes movement.
- or
11. Track warrant outside yard limits authorizes "WORK BETWEEN" two specific points.

### 9.17.1 Signal Protection in ABS by Lining Switch

When a train or engine is within ABS limits and requires action as necessary to stop other trains, this may be provided by lining and locking a main track switch against movement at or beyond the point where the train or engine will stop movement or clear the main track.

If the switch is located within a block other than the one occupied, do not make movements until 5 minutes after the switch has been lined. Also, make sure no train or engine is between the switch and the train or engine being protected or is within or closely approaching the block where the switch is located.

Except where Rule 6.13 (Yard Limits) or Rule 6.14 (Restricted Limits) is in effect, a train must receive permission from the train dispatcher before crossing over to or obstructing another main track signaled for movement in one or both directions.

Train dispatcher must ensure that no other movements against the current of traffic have been or will be authorized. Crew members must notify the train dispatcher when their movement is clear of the other main track.

In addition, before crossing over or fouling a main track, trains must comply with the following:

- a. Do not move until 5 minutes after lining the switch.
- b. Locate the block signal that protects the switch against trains moving with the current of traffic. To move against the current of traffic past that signal, pull the leading engine or car 100 feet beyond the signal. Wait 10 minutes before moving any further against the current of traffic. Then proceed at restricted speed.
- c. To move against the current of traffic beyond any further signals, obtain authority as outlined in Rule 14.6 (Movement Against the Current of Traffic) or Rule 15.3 (Authorizing Movement Against the Current of Traffic).

## 9.18 Electrically Locked Switches and Derails

Special instructions or instructions posted near the switch will govern the operation of switches and derails equipped with electric locks.

To enter a track within manual interlocking or CTC limits, employees must not open the case door or unlock an electrically locked switch or derail without track and time or authority from the control operator.

### Emergency Release

If the electric lock includes an emergency release, do not break the seal on the release or operate the release without permission from the control operator or train dispatcher. However, when communication has failed, the seal may be broken and/or the release operated:

- To permit a train to leave the main track.
- or
- To permit a train that has authority to enter the main track. Train must not enter the main track until 5 minutes after the seal is broken and/or the release operated.

Notify the control operator or train dispatcher when the seal has been broken and/or the emergency release operated.

## 9.19 Leaving Equipment in Signal Systems

Engines, cars, or equipment must not be detached and left standing entirely between the opposing interlocking signals that govern movements at a railroad crossing at grade.

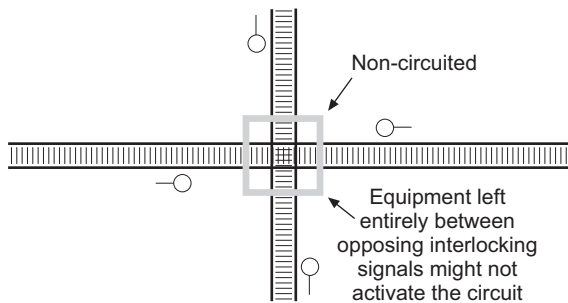

[Diagram A.]

Do not depend upon track equipment, other than engines or cars to actuate block signals, interlocking signals, or highway crossing signals or to be under the protection of such signals.

## 9.20 Clear Track Circuits

A train, engine, car, or equipment left standing on sidings or other tracks must be clear of insulated joints at clearance points.

## 9.21 Overlap Circuits

Overlaps may be identified by overlap signs. A train on the main track at a meeting point must not pass an overlap sign location or open a switch within the overlap until the opposing train has entered the block.

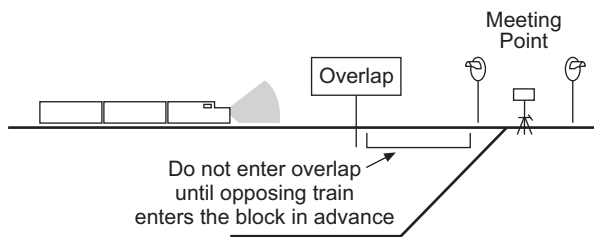

[Diagram A.]

A preceding train must clear the overlap as soon as possible to avoid delaying a following train.

Unless otherwise instructed by the train dispatcher, a train on a siding at a meeting or passing point must not pass an overlap sign location until authorized to leave the siding.

## 9.22 Standing on Sanded Rail

Do not allow an engine with less than three cars, or cuts of four cars or less, to stand on a sanded rail.

## 9.23 Suspension of Block System

When authorized, a track bulletin may suspend the block system or sections of it.

Do not suspend the block system or sections of it until all trains and control operators in the affected territory have been notified by track bulletin specifying the limits of the suspension.

Track bulletins issued to suspend the block system must not be delivered to trains entering the affected territory until the affected limits are clear of trains, or until the track bulletin has been transmitted or delivered to all trains within the limits.

### 9.23.1 Guidelines While Block System is Suspended

When the block system or sections of it are suspended, the following guidelines govern:

- Employees must follow rules that apply to non-signaled territory.
- Trains must receive a track bulletin prescribing speed restrictions that do not exceed 59 MPH for passenger trains or 49 MPH for other trains.
- Trains will disregard extinguished or illuminated block and interlocking signals except where:
  - Signals govern movements over railroad crossings at grade or drawbridges.
  - or
  - Signals are connected with trackside warning detectors.

Trains must approach the block and interlocking signals excepted above and each end of the suspended limits prepared to stop. Trains that leave the limits and move into block system territory must move at restricted speed until they reach the first signal in service beyond the limits. Signals that govern movement over railroad crossings at grade and drawbridges must be regarded as displaying a Stop indication, regardless of the aspect displayed, unless the track bulletin specifies that the signals are in service.

If the crew does not know that signals governing movement over railroad crossings at grade are in service, the crew must provide flag protection in each direction on conflicting routes before proceeding over the crossing. Crew members must not rely on time release or key controller operation as adequate protection while moving over the crossing, unless they are instructed otherwise.

- On multiple main tracks, a track bulletin will designate the track or tracks the block system is suspended on. A track bulletin that specifies the track to be used will be issued to each train.
- Where automatic crossing warning devices have been affected, action to be taken will be stated in the track bulletin.
- Dual control switches on the main track will be lined and locked for main track movement. Switches equipped with selector levers will be locked in the HAND position. All other dual control switches will be spiked. All concerned will be notified. Until informed by the train dispatcher, trains must stop and inspect dual control switches, foul the circuit, and make sure the switch is properly lined before passing over it.

A track bulletin must be issued that specifies which position dual control switches at the end of double track or multiple main tracks are to be left lined.

If a crew member receives notification from the train dispatcher of the position of dual control switches, leave those switches in that position after use.

- Spring switches that will be removed from service must be spiked and those concerned notified.

If spring switches are left in service, trains making facing point movements must be prepared to stop, unless it is known that the switch is properly lined.

- When the block system has been returned to normal operation, a track bulletin must notify all trains within the affected territory before any train can enter the limits and be governed by the block system.

## 9.24 Call Lights

When a call light is on, any employee who sees it, unless the employee is on a moving train, must contact the control operator immediately.

## 10.0 Rules Applicable Only in Centralized Traffic Control (CTC)

### 10.1 Authority to Enter CTC Limits

CTC limits are designated in the timetable. Sidings within CTC limits are controlled sidings and are governed by CTC rules. A train must not enter or occupy any track where CTC is in effect unless a controlled signal displays a proceed indication or the control operator authorizes:

- Movement past a Stop indication under Rule 9.12.1 (CTC Territory).
- A train to enter track between block signals as follows: “(Train) at (location) has authority to enter (track) and proceed (direction).” After entering the track, the train is authorized to move only in the direction specified.

or

- Track and Time under Rule 10.3 (Track and Time).

#### Signal Governing Movement Over a Hand-Operated Switch

If a signal governs movement over a hand-operated switch that is not electrically locked, the control operator must authorize the train to enter or occupy any track where CTC is in effect before the switch is opened. After the switch is opened, if the signal does not display a proceed indication, a crew member must wait 5 minutes at the switch. After the 5 minute wait if the signal does not display a proceed indication, move the train at restricted speed and notify the control operator.

However, if the block to be entered is occupied by its own standing train or when the hand-operated switch remains open, the movement may, after stopping, pass an absolute signal displaying a Stop indication without waiting 5 minutes and without contacting the control operator.

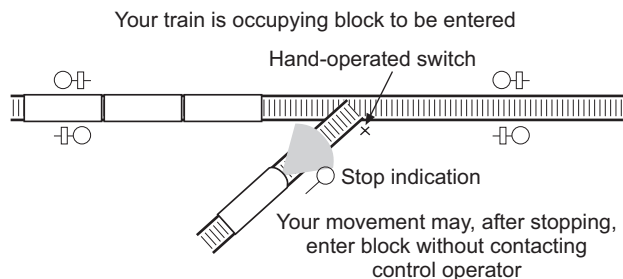

[Diagram A.]

**BNSF Amendment—The following rule is added:**

#### 10.1.1 Leaving the Main Track

Unless authorized by track and time, a crew member must notify the control operator when the train clears the main track unless a crew member is in position to prevent a following movement from passing.

### 10.2 Clearing Through Hand-Operated Switches

Where CTC is in effect, a train must not clear in any track at a hand-operated switch not equipped with an electric switch lock, except under one of the following conditions:

- Where the permanent maximum authorized speed does not exceed 20 MPH on the main track or controlled siding.

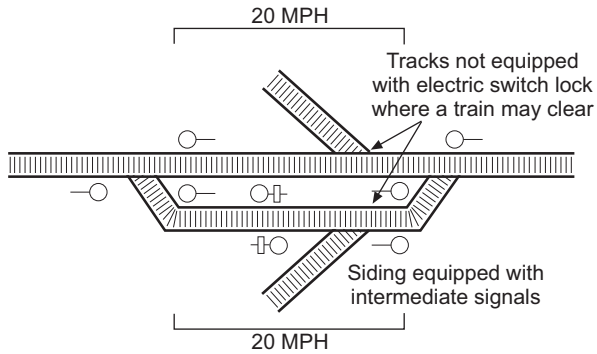

[Diagram A.]

- Where the permanent maximum authorized speed does not exceed 30 MPH on a controlled siding not equipped with an intermediate signal.

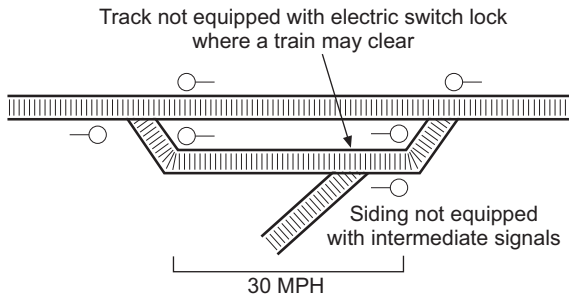

[Diagram B.]

- Where a signal governs movement to a track where CTC is in effect.

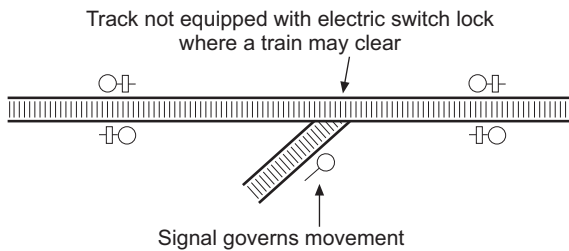

[Diagram C.]

- When the hand-operated switch is kept open.

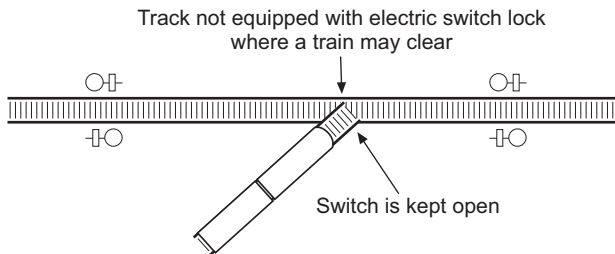

[Diagram D.]

### 10.3 Track and Time

The control operator may authorize a train to occupy a track or tracks within specified limits for a certain time period. Authority must include track designation, track limits, and either a time limit or the words “until released”. The train may use the track in either direction within the specified limits according to signal indication until the limits are verbally released.

Limits designated by a switch extend only to the signal governing movement over the switch unless otherwise designated.

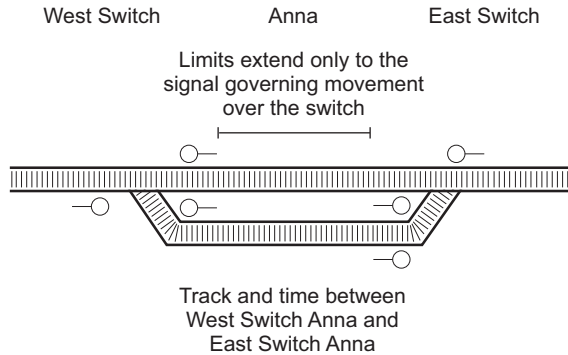

[Diagram A.]

~~Track and time does not authorize trains to occupy the track(s) within interlocking limits.~~

**BNSF Amendment—The instructions inside the box are changed to read:**

Track and time does not authorize trains to occupy the main track within automatic interlocking limits.

#### A. Passing Signal Displaying Stop or Stop and Proceed Indication

Except at interlockings, trains granted track and time:

1. After stopping at a signal displaying a Stop indication, must be granted verbal authority to enter the limits at either end. Verbal authority is not required after stopping within the limits or when entering the limits at any other location. Train must move at restricted speed.
2. Must observe the requirements for inspection of spring switches.
3. May pass a signal within the limits displaying Stop and Proceed indication without stopping.

#### B. Time Limits

Trains must release track and time before the time granted expires. When necessary to modify the expiration time, an employee and the control operator must communicate before time expires to adjust the time granted. If the employee cannot contact the control operator and the time limit expires, authority is extended until the control operator is contacted.

#### C. Releasing When Within the Limits

If no other employee has received track and time within the same limits, a train may release track and time to move in a specified direction. Signal indications will then govern the train, if the control operator verbally authorizes the release specifying direction of movement.

Employees releasing track and time must state:

- Their name or other identification.
- The track and time limits being released, including number, if applicable.

#### D. Releasing Portion of Limits

When a crew member informs the control operator that the authority is released between two specific points, the authority is considered void between those points. This track release must begin at the outer limit of the authority.

### **10.3.1 Protection of Limits**

Before granting track and time, the control operator must apply blocking or marking devices to the control machine to prevent movement into the limits. The control operator may only grant track and time:

1. If the limits are clear.
2. If the limits are occupied by a train with track and time or that will receive track and time.
3. For an engine to switch a train standing within the limits. Crew members on the engine must provide protection against possible movement of the standing train, if necessary.  
or
4. After all trains moving within the limits that do not have track and time have passed the location where the track will be occupied and the employee has been notified that authority is granted behind such trains.

Blocking or marking devices must not be changed or removed until limits have been released to the control operator.

### **10.3.2 Protection of Machines, Track Cars, or Employees**

Machines, track cars, or employees will receive track and time in the same manner as trains.

Machines, track cars, or employees must be clear of the limits before the employee granted track and time releases the authority.

### **10.3.3 Joint Track and Time**

Before track and time is granted where limits will be jointly occupied, the control operator must issue joint track and time to all trains, machines, track cars, or employees within the same limits or that will enter the limits. Trains must move at restricted speed within joint track and time limits.

### **10.3.4 Track and Time Acknowledgment**

Track and time authority must be recorded and repeated to the control operator. Acknowledgment must be received before being acted upon.

The control operator must maintain a record of the authority granted.



## 11.0 Rules Applicable in ACS, ATC and ATS Territories

### 11.1 Establishing Absolute Block

Absolute block may be established in advance of a train. The train dispatcher can establish it verbally or by issuing a track bulletin addressed only to the train affected by stating, "Absolute block is established in advance of your train between \_\_\_\_\_ and \_\_\_\_\_."

### 11.2 Signal Indications with Absolute Block

When absolute block is established in advance of a train, the train must not pass a signal indicating Stop, Stop and Proceed, Restricted Proceed, or Restricting unless verbally authorized by the train dispatcher. However, the train may leave the main track through a switch that is immediately after a signal indicating Stop and Proceed, Restricted Proceed or Restricting.

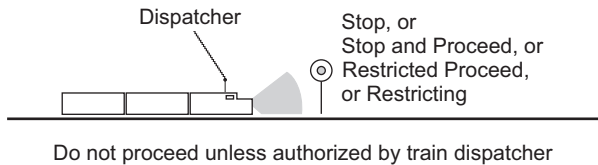

[Diagram A.]

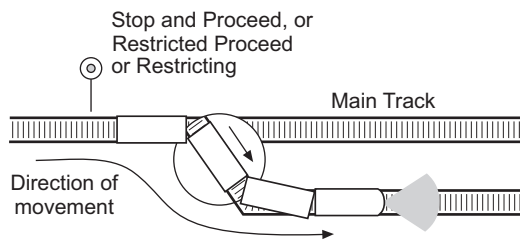

[Diagram B.]

When absolute block is established in advance of a train, the train dispatcher must not authorize the train to pass a signal indicating Stop, Stop and Proceed, Restricted Proceed, or Restricting until the block governed by that signal is clear of trains.

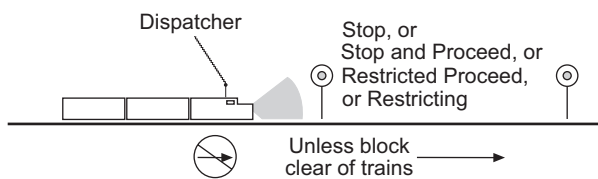

[Diagram C.]

If authorized to pass the signal, the train must proceed at restricted speed until it reaches the next governing signal.

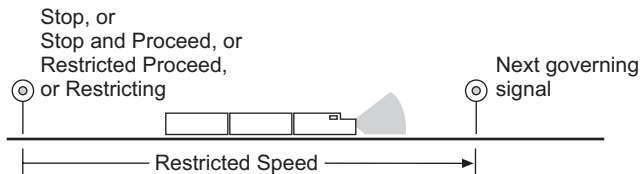

[Diagram D.]

### 11.3 Broken or Missing Seals

Do not break the seal on the cutout cock or cut out ACS or ATS devices unless they do not operate properly. Report ACS or ATS failures, interruptions, and removal of or missing seals to the train dispatcher immediately.

**This page left blank intentionally.**

## 12.0 Rules Applicable Only in Automatic Train Stop System (ATS) Territory

### 12.1 Required Equipment

Except as provided in Rule 12.2 (ATS Device Cut Out, Not Equipped, or Not Working), an engine controlling the air brakes of a passenger train within ATS limits must be equipped with an operative ATS device.

#### 12.1.1 ATS Seals and Keys

When operating in ATS territory, the ATS must be sealed or locked.

### 12.2 ATS Device Cut Out, Not Equipped, or Not Working

Within ATS limits, if the ATS device on an engine controlling the train's air brakes fails or is cut out enroute, or if the engine on a train being detoured is not equipped with a working ATS device, the following will apply:

- The train dispatcher must be notified promptly by radio or telephone.
- The train may proceed according to signal indication, but cannot exceed 40 MPH until an absolute block is established in advance of the train.
- If an absolute block is established in advance of the train as provided in Rule 11.1 (Establishing Absolute Block), the train may proceed according to signal indication, but cannot exceed 79 MPH.

### 12.3 Unusual Conditions

#### 12.3.1 ATS Penalty Brake Application

When two successive ATS penalty brake applications have occurred while passing over inductors at signals displaying Proceed, engineer must acknowledge at each succeeding inductor thereafter, regardless of signal indications and report to the train dispatcher.

#### 12.3.2 ATS Inoperative

The ATS system is considered inoperative when:

- Acknowledging at subsequent inductors at signals when required by Rule 12.3.1 (ATS Penalty Brake Applications), or at two successive inert inductors, does not prevent penalty stops.
- The acknowledgment alarm fails to sound or light fails to illuminate when acknowledgment is required at an inductor at a wayside signal indicating other than Proceed.
- Brakes do not apply upon failure to acknowledge a signal indicating other than Proceed.  
or
- Absence of, or damage to, an ATS receiver is noted.

#### 12.3.3 Damaged Inductor

Employees noting the absence of or damage to a wayside inductor in approach to a signal must notify the train dispatcher. The train dispatcher must immediately call the signal maintainer who must cause the signal to display its most restrictive indication until inductor is replaced or repaired.

## 12.4 ATS Testing

### 12.4.1 Test Inductor Locations

1. Move engine at 3 MPH or more over first inductor while holding the acknowledging device in full position (not over 15 seconds) to determine that brake application does not occur.
2. Move engine at 3 MPH or more over second inductor and do not acknowledge. A brake application should occur. Operate reset device to full position and release brakes.
3. Report as prescribed in Rule 17.4.1.

### 12.4.2 No Test Inductors

At locations where there are no test inductors:

1. Pass a test bar under the ATS receiver while holding the acknowledging device in full position (not over 15 seconds) to determine that brake application does not occur.
2. Pass a test bar under the ATS receiver and do not acknowledge device. A brake application should occur. Operate reset device to full position and release brakes.
3. Report as prescribed in Rule 17.4.1.

## 13.0 Rules Applicable Only in Automatic Cab Signal System (ACS) Territory

### 13.1 General Information

#### 13.1.1 Observance of Signals

The Automatic Cab Signal (ACS) system is used in addition to block signals to govern the use of blocks. However, employees must continue to observe rules that govern the use of block signals as well as other rules, except as outlined in Rules 13.2.1 (Restrictive to More Favorable) and 13.2.2 (Favorable to More Restrictive).

#### 13.1.2 Conforming with Block Signals

The cab signal and block signal systems are interconnected so that the cab signal agrees with the block signal indication within 8 seconds after the engine passes the block signal that governs entrance into a block.

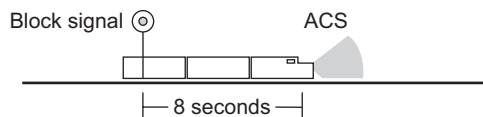

[Diagram A.]

#### Exception

The ACS system is to be considered inoperative through turnouts and crossovers. Block signal indications and speeds specified in the special instructions for each turnout govern movements through turnouts and crossovers.

#### 13.1.3 Does Not Indicate Conditions Ahead

Cab signals will not indicate conditions ahead when the engine is:

- Moving against the current of traffic.
- Shoving cars.
- or
- Moving backward and not equipped for backward operation.

### 13.1.4 Cab Signals Cut In and Out

The cab signal on the lead unit must be cut in before entering and while operating within ACS territory and placed in partial cutout after leaving ACS territory.



[Diagram A.]

The cab signal must be placed in partial cutout on all trailing units in ACS territory.

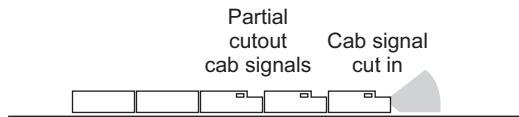

[Diagram B.]

**BNSF Amendment—The last sentence is deleted from the last paragraph:**

Before taking charge of an engine in or approaching ACS territory, the engineer must know that the cab signal devices are cut in and operative and that the ACS cutout is properly sealed. If the device was cutout or seal is missing upon taking charge of a locomotive, the ACS equipment must be re-tested. If device was previously tested and fails to function properly upon entering, or while operating in ACS territory, the train dispatcher must be notified and the train must be operated under an absolute block. ~~If the device was not tested previously, the engineer must make a departure test prior to entering ACS territory.~~

**Do not cut out cab signal devices while the train is in ACS territory, unless authorized to do so.**

**BNSF Amendment—The following note is added:**

Note: Partial cutout requirements do not apply to engines not so equipped.

## 13.2 Normal Operation

### 13.2.1 Restrictive to More Favorable

Cab signal indications do not supersede the indication displayed on block and interlocking signals. However, when a cab signal changes to a more favorable indication after having passed the block or interlocking signal, the train may immediately comply with the indication.

### 13.2.2 Favorable to More Restrictive

When a cab signal changes to a more restrictive indication, the engineer must comply promptly with the indication received.

#### Acknowledging Restrictive Indication

When a cab signal changes to a more restrictive indication, the engineer must acknowledge the change with the acknowledging device. On engines not equipped with the Coded Cab Signal-Safety Control (CCS-SC) System, another member of the crew must immediately find out from the engineer why the warning whistle sounded longer than 6 seconds. When conditions require, the crew member must stop the train immediately.

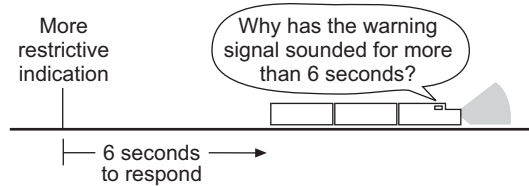

[Diagram A.]

On engines equipped with CCS-SC, the engineer must acknowledge the change within 6 seconds of receiving it to avoid a penalty brake application.

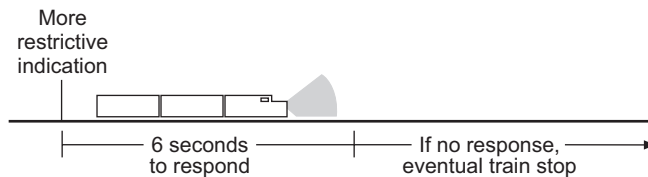

[Diagram B.]

#### Penalty Brake Application Occurs

On engines equipped with CCS-SC, if the engineer does not acknowledge the more restrictive indication, a full service penalty brake application will occur automatically within 6 to 8 seconds. When this occurs, the engineer must do the following:

- Place the automatic brake valve handle in suppression position and leave it there until the train stops.
- Place the throttle in idle position.
- Acknowledge the signal change with the acknowledging device.
- After the train has stopped and the P.C. light goes out, place the automatic brake valve handle in release position.

### 13.2.3 Elimination of Audible Indicator

To keep the audible indicator from sounding while the train is stopped in a cab signal test loop, place the reverser handle in either the neutral or reverse position. This will change the cab signal to its most restrictive aspect. After acknowledging the signal change, no more signal changes will be received.

Place the reverser handle in the forward position to automatically restore the equipment to normal operation.

Since the reverser handle in trailing units is in neutral position, the audible indicator is automatically silenced on trailing units.

## 13.3 Unusual Conditions

### 13.3.1 Cab Signal and Block Signal Do Not Agree

If the cab signal does not display the proper ACS aspect shown in the Block and Interlocking Signal Rules:

- The most restrictive block or cab signal indication must be complied with. A crew member must promptly notify the train dispatcher of the location, signal number, and track where the signals did not agree.
- At control point locations with only an absolute signal(s), when authorized by the train dispatcher to pass the Stop indication, the cab signal may change to a more favorable indication at the signal. The train may comply with the cab signal indication. This is normal due to track circuitry and would not be considered an improper display of the cab signal.

**BNSF Amendment—Delete the following exception:**

**Exception**

When the train dispatcher's instructions require the train to proceed at Restricted Speed, the train must comply with the train dispatcher's instructions regardless of cab signal indication.

### 13.3.2 Inoperative Cab Signal Device

The ACS system is to be considered inoperative when:

- The audible indicator does not sound when the cab signal changes to a more restrictive indication.
  - The audible indicator continues to sound when the cab signal change is acknowledged.
  - The cab signal does not conform at two consecutive block or interlocking signal locations.
- or
- Any part of the cab signal device is damaged.

**Known in Advance**

When it is known in advance that the ACS system is inoperative in a specific area, crew members will be notified with a track bulletin.

### 13.3.3 Movement with an Inoperative Cab Signal Device

**BNSF Amendment—Entire rule is changed to read:**

When it is determined the cab signal device is inoperative, the train may proceed according to block signal indications. However, the train must not exceed 40 MPH until it reaches a point where a crew member can report the defect to the train dispatcher.

The train dispatcher will establish an absolute block in advance of the train.

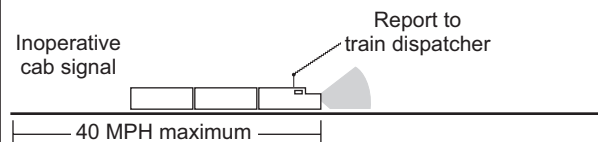

[Diagram A.]



# 14.0 Rules Applicable Only Within Track Warrant Control (TWC) Limits

**TRACK WARRANT**  
(Suggested Form)

NO: \_\_\_\_\_  
TO: \_\_\_\_\_

1.  TRACK WARRANT NO. \_\_\_\_\_ IS VOID.
2.  PROCEED FROM \_\_\_\_\_ TO \_\_\_\_\_ ON \_\_\_\_\_ TRACK.
3.  PROCEED FROM \_\_\_\_\_ TO \_\_\_\_\_ ON \_\_\_\_\_ TRACK.
4.  WORK BETWEEN \_\_\_\_\_ AND \_\_\_\_\_ ON \_\_\_\_\_ TRACK.
5.  NOT IN EFFECT UNTIL \_\_\_\_\_.
6.  THIS AUTHORITY EXPIRES AT \_\_\_\_\_.
7.  NOT IN EFFECT UNTIL AFTER ARRIVAL OF \_\_\_\_\_ AT \_\_\_\_\_.
8.  HOLD MAIN TRACK AT LAST NAMED POINT.
9.  DO NOT FOUL LIMITS AHEAD OF \_\_\_\_\_.
10.  CLEAR MAIN TRACK AT LAST NAMED POINT.
11.  BETWEEN \_\_\_\_\_ AND \_\_\_\_\_ MAKE ALL MOVEMENTS AT RESTRICTED SPEED. LIMITS OCCUPIED BY TRAIN.
12.  BETWEEN \_\_\_\_\_ AND \_\_\_\_\_ MAKE ALL MOVEMENTS AT RESTRICTED SPEED. LIMITS OCCUPIED BY MEN OR EQUIPMENT.
13.  DO NOT EXCEED \_\_\_\_\_ MPH BETWEEN \_\_\_\_\_ AND \_\_\_\_\_.
14.  DO NOT EXCEED \_\_\_\_\_ MPH BETWEEN \_\_\_\_\_ AND \_\_\_\_\_.
15.  FLAG PROTECTION NOT REQUIRED AGAINST FOLLOWING TRAINS ON THE SAME TRACK.
16.  TRACK BULLETINS IN EFFECT \_\_\_\_\_, \_\_\_\_\_, \_\_\_\_\_, \_\_\_\_\_, \_\_\_\_\_, \_\_\_\_\_, \_\_\_\_\_, \_\_\_\_\_.
17.  OTHER SPECIFIC INSTRUCTIONS: \_\_\_\_\_  
\_\_\_\_\_  
\_\_\_\_\_  
\_\_\_\_\_

OK \_\_\_\_\_ (TIME) DISPATCHER \_\_\_\_\_

LIMITS REPORTED CLEAR AT \_\_\_\_\_

(Mark the box for each item instructed.)

[Diagram A.]

## 14.1 Authority to Enter TWC Limits

Where designated by the timetable, a track warrant will authorize main track use under the direction of the train dispatcher or as prescribed by Rule 6.13 (Yard Limits) or Rule 6.14 (Restricted Limits). Track warrant instructions must be followed where yard limits or restricted limits are in effect.

## 14.2 Designated Limits

Track warrant limits must be designated by specifying track, where required, and specific locations such as switches, mile posts, or railroad identifiable points. However, station names may be used as follows:

### A. First Named Point

When a station name designates the first named point, authority extends from and includes the last siding switch. Authority extends from the station sign if no siding exists.

### B. Last Named Point

When a station name designates the last named point, authority extends to and includes the first siding switch. Authority extends to the station sign if no siding exists.

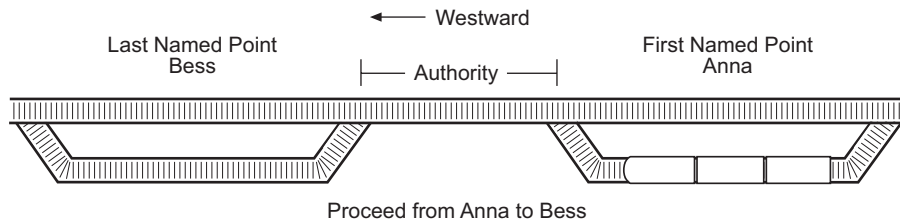

[Diagram A.]

At the last named point, authority extends to but does not include the last siding switch when the track warrant states, "Hold main track at last named point."

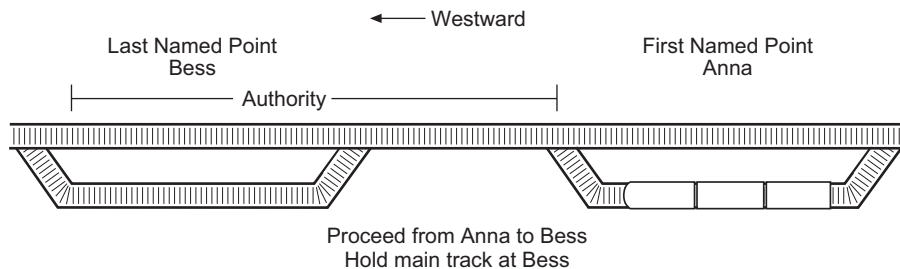

[Diagram B.]

## 14.3 Operating with Track Warrants

A track warrant authorizes a train or engine to occupy the main track within designated limits. However, the train or engine must not foul a switch at either end of the limits where an opposing train may use the same switch to clear the main track.

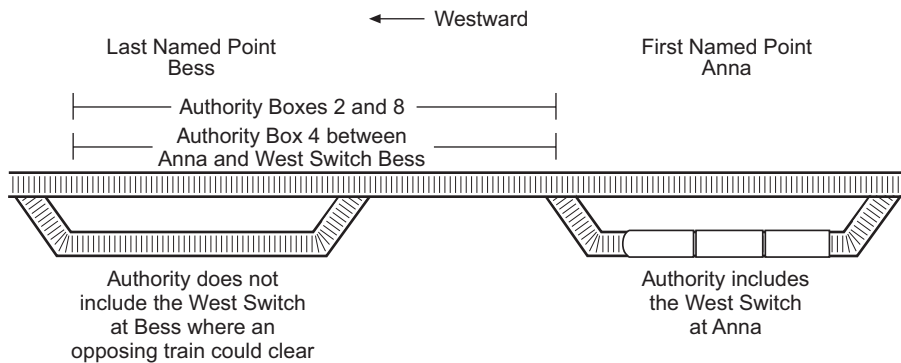

[Diagram A.]

The train or engine must move as follows:

1. Proceed from one point to another in the direction the track warrant specifies. When a crew member informs the train dispatcher that the entire train has passed a specific point, track warrant authority is considered void up to that point.

**BNSF Amendment—The following is added to Item 1:**

Record the location of the specific point on the track warrant form.

or

2. If authorized to “WORK BETWEEN” two specific points, the train or engine may move in either direction between those points. When a crew member informs the train dispatcher that the authority is released between two specific points, the authority is considered void between those points. This track release must begin at the outer limit of the authority.

**BNSF Amendment—The following is added to Item 2:**

Record the location of the specific points on the track warrant form.

### 14.3.1 Leaving the Main Track

A train authorized to proceed in one direction must inform the train dispatcher when it leaves the main track before reaching the last named point, unless a crew member is left to prevent a following movement from passing.

## 14.4 Occupying Same Track Warrant Limits

A track warrant must not be issued to a train within the same or overlapping limits with another train unless:

1. In signaled territory, all trains are authorized to proceed in the same direction.
2. In non-signaled territory, all trains are authorized to proceed in the same direction and are instructed to move at restricted speed.
3. Two or more trains are authorized to “WORK BETWEEN” two specific points at restricted speed within the overlapping limits.
4. Trains are authorized to proceed through the limits of another train authorized to “WORK BETWEEN” two specific points, and track warrants instruct all trains to move at restricted speed within the overlapping limits. When station name(s) designate the overlapping limits, refer to Rule 14.2 (Designated Limits) for limits where trains are required to move at restricted speed.

or

5. Radio Blocking is authorized as outlined by Rule 14.4.1 (Radio Blocking).

Where track warrant authority includes yard limits or restricted limits, the terms of Rule 6.13 (Yard Limits) or Rule 6.14 (Restricted Limits) apply, but track warrant instructions must be followed.

### 14.4.1 Radio Blocking

Where designated by special instructions, in non-signaled territory, more than one train may be authorized to proceed in the same direction within the same or overlapping limits, provided the following train:

- Is notified on the track authority of the identity of the preceding train.
- Does not occupy the limits ahead of the preceding train.
- Notifies the crew of the preceding train that radio blocking has been authorized stating the limits.
- Is notified by the preceding train that the entire train has passed a specific location. Location specified must not be beyond limits indicated. The following words must be used: “(Train) clear of (location)”.
- Does not proceed beyond the last location the preceding train has reported to have passed.

All instructions between the trains must be written, repeated, and acknowledged with “THAT IS CORRECT” before being acted on. These written instructions between the trains must be retained until the end of tour of duty.

Notify the train dispatcher if communication cannot be established between the two trains. If necessary, radio blocking information may be relayed only by the train dispatcher.

The last named point of the following train’s authority must not extend beyond the last named point of the preceding train’s authority.

In the application of Rule 6.4 (Reverse Movements) and Rule 6.6 (Picking Up Crew Member), the movement must not go beyond the last specific location reported to the following train.

<b>Written Instructions Between Trains</b>			
(Suggested Form)			
( <i>Following Train ID</i> ) is authorized Radio Blocking from _____ to _____ behind ( <i>Preceding Train ID</i> ).			
	<b><u>LOCATION</u></b>	<b><u>TIME</u></b>	<b><u>CREW MEMBER</u></b>
( <i>Preceding Train ID</i> ) clear of	_____ at	_____	reported by _____
	_____ at	_____	reported by _____
	_____ at	_____	reported by _____
	_____ at	_____	reported by _____
	_____ at	_____	reported by _____

## 14.5 Protecting Men or Equipment

Men or equipment may receive a track warrant in the same manner as trains to occupy or perform maintenance on the main track without other protection.

A track warrant must not be issued to protect men or equipment within the same or overlapping limits with a train unless:

1. All trains are authorized to proceed in one direction only, and the track warrant specifies that men or equipment do not occupy limits ahead of these trains.  
or
2. All trains authorized are notified of the men or equipment and have been instructed by track warrants to move at restricted speed within overlapping limits. When station name(s) designate the overlapping limits, refer to Rule 14.2 (Designated Limits) for limits where trains are required to move at restricted speed. Also, a track warrant must inform the employee in charge of men or equipment about the trains. If the track is not safe for trains to move at restricted speed, the employee must protect the track with red flags according to Rule 5.4.7 (Display of Red Flag or Red Light).

## 14.6 Movement Against the Current of Traffic

When a track warrant authorizes a train to move against the current of traffic, the train must use only the track designated within the specified limits. This train must not allow a train following on the same track to pass, unless the train dispatcher instructs it to pass.

## 14.7 Reporting Clear of Limits

A train without a crew member on the rear and operating in non-signaled or double track territory may report clear of the limits, report having passed a specific location, or release the track between two specific locations only when it is known the train is complete. This must be determined by one of the following ways:

1. The rear of the train has a rear-end telemetry device, and air pressure on the head-end device indicates brake pipe continuity.
2. An employee verifies the marker is on the rear of the train.
3. A crew member can observe the rear car of the train on which the marker is placed.
4. The train is stopped, and an inspection verifies that the marker is on the rear car of the train.
5. A trackside warning detector transmits an axle count for the train, and the axle count duplicates the axle count transmitted by the previous trackside warning detector.

In addition, a train clearing in a siding or other track must comply with requirements outlined in Rule 8.3 (Main Track Switches) before reporting clear of the limits.

**BNSF Amendment—Delete the following paragraph:**

~~When a hand-operated switch is used to clear the main track, except where Rule 6.13 (Yard Limits) or Rule 6.14 (Restricted Limits) are in effect, advise the train dispatcher of the position of the switch and that the switch is locked when reporting clear of track warrant limits. Train dispatcher shall repeat the reported switch position and employee releasing the limits shall confirm to the train dispatcher this information is correct.~~

## 14.8 Track Warrant Requests

An employee who requests a track warrant must inform the train dispatcher what movements will be made and, when necessary, which tracks will be used and how much time is required.

## 14.9 Copying Track Warrants

The conductor and the engineer must each have a copy of the track warrant issued to their train, and each crew member must read and understand it. The copy must show the date. The following must occur when transmitted verbally:

### ~~A. Transmitting Track Warrants~~

- ~~1. An employee will enter all of the information and instructions on the track warrant.~~
- ~~2. The employee will repeat the preprinted and written information transmitted by the train dispatcher.~~
- ~~3. The train dispatcher will check it and, if correct, will say "OK" and give the time and his initials.~~
- ~~4. The employee will enter the "OK" time and the train dispatcher's initials on the track warrant and repeat them to the train dispatcher.~~

### **BNSF Amendment—Item A is changed to read:**

#### **A. Transmitting Track Warrants**

1. The train dispatcher will transmit the track warrant, followed by a summary of the total number of boxes and individual box numbers included by stating:

"(total number) boxes marked:

(Individual box numbers)."

2. An employee will enter all of the information transmitted by the train dispatcher, except the summary. As the summary is transmitted, the employee will check the total number of boxes and individual box numbers copied to ensure all items are included.

3. The employee will repeat the preprinted and written information transmitted by the train dispatcher, followed by a summary of the total number of boxes and individual box numbers included by stating:

"(total number) boxes marked:

(Individual box numbers)."

4. The train dispatcher will check the repeat and, if all information including the summary is correct, will state the following:

"Authority (number) OK (time) (dispatcher initials)".

The employee will enter the OK time and the train dispatcher's initials on the track warrant and repeat them to the train dispatcher,

or

If the track warrant includes after arrival, the dispatcher will state the following:

"Authority (Number) with after arrival of (train) at (location) OK (time) (dispatcher initials)."

The employee will enter the OK time and the train dispatchers initials on the track warrant and repeat the "After Arrival" information, OK time and dispatcher's initials to the train dispatcher.

Note: The summary information in Items 1, 2, 3 and the after arrival information in Item 4 will be exempt from pronouncing and spelling numbers as indicated in GCOR 2.14.1, Verbally Transmitting and Repeating Mandatory Directives.

**B. In Effect**

1. The track warrant is not in effect until the “OK” time is shown on it.
2. If the track warrant restricts movement or previously granted authority, it cannot be considered in effect by the train dispatcher until acknowledgment of the “OK” has been received.

Employees may relay track warrants:

**BNSF Amendment—The last sentence is changed to read:**

Rules qualified employees may relay track warrants.

**14.9.1 Duplicating Track Warrants**

Employees who reproduce track warrants with a duplicating machine do not need to repeat them to the train dispatcher.

Duplicated track warrants must not be delivered or used until they are checked and verified as:

- Legible.
- Duplicated in their entirety.

**14.10 Track Warrant in Effect**

**BNSF Amendment—Entire rule is changed to read:**

A track warrant is in effect until a crew member reports the train has cleared the limits, or the track warrant is made void. The crew member must inform the train dispatcher when the train has cleared the limits. Before a train reports clear of a track warrant, the track warrant is made void or a portion of track warrant limits are released, a crew member must restore hand operated main track switches to normal position unless relieved by track warrant.

Employees reporting clear of track warrant limits must state:

- Their name or other identification
- Track warrant number being released
- Limits being released

In non-signaled territory or double track ABS territory (outside of restricted limits or yard limits), a crew member will job brief with the train dispatcher about the position of main track switches and those switches operated are locked within the limits being released, referencing completion of the Position of Switch form or stating no entries required.

**Time Limit Shown**

If the track warrant shows a time limit, the train must clear the limits by the time specified, unless another track warrant is obtained. If an employee cannot contact the train dispatcher and the time limit expires, authority is extended until the train dispatcher is contacted.

## 14.11 Changing Track Warrants

Employees must not add to or alter the track warrant in any manner, except as specified by Rule 15.1.1 (Changing Address of Track Warrants or Track Bulletins).

When the limits or instructions of a track warrant must be changed, a new track warrant must be issued showing, "Track Warrant No. \_\_\_\_\_ is void" and the number of the track warrant being changed. When a track warrant of a previous date is voided, the date must be included. The previous track warrant will no longer be in effect.

## 14.12 Not Used

## 14.13 Mechanical Transmission of Track Warrants

Repetition is not required when track warrants are transmitted mechanically. The "OK" time will be given when the track warrant is issued.

Track warrants that restrict the authority or movement of a train must not be transmitted mechanically, unless the train being restricted will not leave the point without receiving the track warrant.



# 15.0 Track Bulletin Rules

(Suggested Form)  
Track Bulletin Form A

No. \_\_\_\_\_ On \_\_\_\_\_ SUBDIV. \_\_\_\_\_  
To \_\_\_\_\_

Between points shown in lines 1 through 10 below, do not exceed speed given:  
(Use last two columns when displayed less than distance prescribed by Rule 5.4.2 to indicate location and direction.)

Line Void	Line No.	Between/At Location & Location	Speed MPH		Track(s)	Flags At MP	For Direction	
			PSGR	FRT				
	1.							
	2.							
	3.							
	4.							
	5.							
	6.							
	7.							
	8.							
	9.							
	10.							
	11.	Other Conditions _____						
		OK _____ Dispatcher _____						

[Diagram A.]

(Suggested Form)  
Track Bulletin Form B

No. \_\_\_\_\_ On \_\_\_\_\_ SUBDIV. \_\_\_\_\_  
To \_\_\_\_\_

On (Date) \_\_\_\_\_ Be governed by Rules 15.2 and 15.2.1 within the following limits:  
(Use last two columns when displayed less than distance prescribed by 5.4.3 to indicate location and direction.)

Line Void	Line No.	Between Location & Location	From	Until	Track(s)	Foreman and/or Gang No.	Y/R Flag At MP	For Direction
	1.							
	2.							
	3.							
	4.							
	5.							
	6.							
	7.							
	8.							
	9.							
	10.							
		OK _____ Dispatcher _____						

[Diagram B.]

## 15.1 Track Bulletins

Track bulletins must not be changed unless specified by Rules 15.1.1 (Changing Address of Track Warrants or Track Bulletins) or Rule 15.13 (Voiding Track Bulletins). The train dispatcher will issue track bulletins as required. Track bulletins will contain information on all conditions that affect safe train or engine movement. Forms other than track bulletin Forms A and B may be used when necessary.

### Receipt and Comparison of Track Bulletins

The conductor and engineer must receive a track warrant at their initial station unless otherwise instructed by the train dispatcher. All track bulletins that affect their train's movement must be listed on the track warrant, unless the track warrant shows "NONE" or "NO." The conductor and engineer must have copies of all track bulletins listed and other instructions required. Each crew member must read and understand them.

All crew members are responsible for complying with the requirements of track bulletins and reminding each other of those requirements.

At the initial station, when outbound crew members receive track warrants and track bulletins from inbound crew members, the conductor and engineer must compare the track warrants and track bulletins with each other and with the train dispatcher before proceeding.

At locations where track warrants listing track bulletins are received by printer or fax, crew members must verify that route description, if printed, covers the intended route of their train. If it does not, contact the train dispatcher and determine if the track warrant is valid. Also, crew members must check the date and "OK" time on the track warrant and if the track warrant is over 4 hours old, contact the train dispatcher and determine if additional track bulletins are needed.

Any rule referencing track warrants is also applicable to DTC authority.

### 15.1.1 Changing Address of Track Warrants or Track Bulletins

If the address must be changed on a track warrant used to deliver track bulletins only or a track bulletin that does not grant authority according to Rule 15.3 (Authorizing Movement Against the Current of Traffic), the train dispatcher may verbally change the train symbol, engine identification, direction, or date.

## 15.2 Protection by Track Bulletin Form B

Display track flags as specified in Rule 5.4.3 (Display of Yellow-Red Flag) and Rule 5.4.7 (Display of Red Flag or Red Light).

A train must not enter the limits unless instructed by the employee in charge. A train within the limits at the time the track bulletin Form B takes effect must not make further movement until instructed by the employee in charge.

A crew member must attempt to contact the employee in charge of a track bulletin Form B to avoid delay, giving the train's location and track being used. The employee in charge will use the following format to establish communication with the train:

Foreman (name and/or gang number) using Track Bulletin No. \_\_\_\_ (specifying line number when necessary) between MP \_\_\_\_ and MP \_\_\_\_ (specifying subdivision when necessary).

Trains within the limits of a track bulletin Form B, unless otherwise restricted, must move at the speed(s) specified by the employee in charge as stated in Item A (Instructions).

### A. Instructions

After communication with the train has been established, the employee in charge will use the following format to grant a train permission to proceed through the Form B limits:

- (Train ID) may pass the red flag (or red light) at MP \_\_\_\_ (without stopping) and proceed at (one of the following), (specifying track when necessary):
  - "Maximum Authorized Speed"
  - "Restricted Speed"
  - A speed specified by the employee in charge

Two additional speeds may be given to restrict a train's movement through a portion of the limits, by adding the following:

- Do not exceed \_\_\_\_MPH between/at MP \_\_\_\_ and MP \_\_\_\_ (or other location).

To require a train to stop at a designated location within the limits, add the following:

- Stop at MP \_\_\_\_ (or other location) until additional instructions are received.

When men or equipment foul adjacent track(s), add the following:

- Men or equipment fouling (specify track).

#### **B. Repeat Instructions**

A crew member must repeat the above instructions, and the employee giving the instructions must acknowledge them before they can be followed.

Once instructions are received from employee in charge, if the track route changes from previous instructions received, contact employee in charge to determine that original instructions received are valid on new track route before proceeding on the new route. The movement must not change direction without permission from the employee in charge.

**BNSF Amendment—The following rule is added:**

#### **C. Stop Column**

When "STOP" is written in the Stop column, the train must not enter the limits unless instructed by the employee in charge. A red flag or red light may be displayed at the beginning of the limits. A train within the limits at the time the track bulletin Form B takes effect, must not make further movement until instructed by the the employee in charge.

**BNSF Amendment—The following rule is added:**

#### **D. Entering Within Limits**

Before entering the track governed by the track bulletin Form B from any location other than the beginning of the Form B limits, obtain permission from the employee in charge.

### **15.2.1 Protection for On-Track Equipment**

Track bulletin Form B may be used to protect on-track equipment, such as rail detector cars, without using yellow-red flags. Identify protected equipment in the track bulletin.

While trains, engines, and protected equipment are in track bulletin limits, they will otherwise be governed by Rule 15.2 (Protection by Track Bulletin Form B). The same track bulletin must not protect other gangs and equipment.

## **15.3 Authorizing Movement Against the Current of Traffic**

Where Rule 9.14 (Movement with the Current of Traffic) is in effect, a track bulletin may authorize movement against the current of traffic as follows:

1. "(Train) will use \_\_\_\_ track against the current of traffic (point) to (point)."

The train must use only the track specified between these points. Opposing trains must not leave the last point until the train arrives. The train dispatcher must not authorize a following train to move against the current of traffic until the previous train has cleared the last point.

The example may be modified as follows:

- a. “After (opposing train) arrives at (point), (train) will use \_\_\_\_\_ track against the current of traffic (point) to (point).”

The train that will move against the current of traffic must not leave the first point until the opposing train arrives.

Trains directly affected in both directions must receive this track bulletin and must not:

- Clear the main track.
  - Allow a following train to pass.
- or
- Pass a preceding train, unless authorized by the train dispatcher.

2. “(Time) until (time) (date), all trains use \_\_\_\_\_ track between (point) and (point). All trains must stop before fouling \_\_\_\_\_ track between these points unless directed to proceed by employee in charge of switches or by train dispatcher.”

This bulletin may also contain information on public crossing protection, switches spiked, intermediate flagman, and so forth.

**Following Movement.** A train may not follow another train against the current of traffic until the previous train has cleared the limits, passed a designated location, or passed a flagman located at the next intermediate point. Flag protection is not required against following trains.

**Flagman Provided.** When flagmen are provided, the example will be modified by adding:

- “Intermediate flagman located at (point). Trains moving against the current of traffic must stop short of flagman unless directed to proceed.”

**Extending Time.** Time may be extended by issuing another track bulletin as follows:

- “Track bulletin No. \_\_\_\_\_ is extended until (time).”

This bulletin will be used when one or more tracks will be removed from service, and all trains in both directions must use the remaining track as directed by the train dispatcher or an employee in charge of switches at each end of the designated limits.

The train dispatcher will authorize movement between the designated points and issue the track bulletin and necessary instructions to the employee in charge of switches. This employee may verbally direct movement or use hand signals. Also, the train dispatcher may use a controlled signal indication to authorize movement.

All affected trains must receive a copy of the track bulletin.

## 15.4 Protection When Tracks Removed from Service

Before a track is removed from service it must be protected.

A track bulletin may protect tracks removed from service by designating the track and naming the points at each end of the track. Trains must not use this track, unless the track bulletin states the name or title of an employee who may authorize use, and this person directs all movement. Movements must be made at restricted speed.

Proper authority must also be received to pass an absolute signal displaying a Stop indication to enter the out of service track. Except at interlockings, after stopping, movements may pass Stop indications within the out of service limits. Movements within the out of service limits may pass Stop and Proceed indications without stopping.

When required, the train dispatcher must advise crews of alternate routes and switch positions.

## 15.5 Protection When Tracks Blocked with Equipment

Notify the train dispatcher when main tracks, sidings, or other tracks that are normally clear are blocked with equipment and cannot be cleared.

When the main track is blocked, provide protection as specified by Rule 6.20 (Equipment Left on Main Track).

## 15.6 Change of a General Order, Special Instruction, or Rule

When authorized by the designated manager, a track bulletin may be used to issue, change, or cancel general orders, special instructions, or rules.

General orders or special instructions canceled by track bulletins must not be reinstated. The track bulletin must remain in effect until the general order that contains the change is posted.

## 15.7 Copying Track Bulletins

The conductor and the engineer must each have a copy of the track bulletins issued to their train, and each crew member must read and understand them. The copy must show the date. The following must occur when track bulletins are transmitted verbally:

1. An employee will enter all of the information on the track bulletin.
2. The employee will repeat the information to the train dispatcher.
3. The train dispatcher will check it and, if correct, will say “OK” and give the time and his initials.
4. The employee will enter the “OK” time and the train dispatcher’s initials on the track bulletin and repeat them to the train dispatcher.

Employees may relay track bulletins.

## 15.8 Duplicating Track Bulletins

Employees who reproduce track bulletins with a duplicating machine do not need to repeat them to the train dispatcher.

Duplicated track bulletins must not be delivered or used until they are checked and verified as:

- Legible.
- Duplicated in their entirety.

## 15.9 Mechanical Transmission of Track Bulletins

Repetition is not required when track bulletins are transmitted mechanically. The “OK” time will be given when the track bulletin is issued.

## 15.10 Retaining Track Bulletins

Employees must keep and comply with track bulletins on all trips during the tour of duty when track bulletins were received.

When directed by the train dispatcher, track bulletins may be retained for use during the next tour of duty. Before initiating movement on the main track on the next tour of duty, a crew member must verify from the train dispatcher that no additional track bulletins are needed.

## 15.11 Not Used

## 15.12 Relief of Engineer or Conductor During Trip

When a conductor, engineer, or both are relieved before a trip is finished, they must contact the train dispatcher and comply with instructions concerning the handling of their track warrants, track bulletins, and other instructions.

When crew members are called to relieve a train at other than the initial station, crew members must contact the train dispatcher before leaving the initial station and determine if any track warrants, track bulletins, or other instructions must be obtained.

### Comparison of Information

The relieving conductor and engineer must compare track warrants, track bulletins, instructions, and pertinent information with each other and with the train dispatcher before proceeding.

## 15.13 Voiding Track Bulletins

To void a numbered line on a track bulletin, a part of a track bulletin, or an entire track bulletin, the train dispatcher may do one of the following:

### A. Voiding Track Bulletins Verbally

Void the track bulletin by verbally using one of the following examples:

1. "Line (number) of track bulletin No. \_\_\_\_ reading (quote the line to be voided) is void."
2. "That part of track bulletin No. \_\_\_\_ reading (quote the part to be voided) is void."
3. "Track bulletin No. \_\_\_\_ is void."

Employee must repeat the information to the train dispatcher. If correct, the word "VOID" will be entered to indicate that portion is no longer in effect.

### B. Issue Track Bulletin or a Track Warrant to Void a Track Bulletin

Issue a track bulletin or use the line designated "OTHER SPECIFIC INSTRUCTIONS" on a track warrant using one of the following examples:

1. "Line (number) of track bulletin No. \_\_\_\_ is void."
2. "That part of track bulletin No. \_\_\_\_ reading (quote the part to be voided) is void."
3. "Track bulletin No. \_\_\_\_ is void."

Where paper copies are used, employee will keep a copy of the track warrant or track bulletin that made it void and the word "VOID" will be entered to indicate that portion is no longer in effect.

The track bulletin or the part of the track bulletin indicated will no longer be in effect.

**BNSF Amendment—The following rule is added:**

### 15.13.1 Voiding General Track Bulletins or Restrictions

To void a bulletin restriction or an entire general track bulletin, train dispatcher may do the following:

1. "Restriction (number) \_\_\_\_ reading \_\_\_\_ is void."

An employee must repeat this information to the train dispatcher. If the information is correct, the employee must write "Void" in the margin to the left of the restriction made void.

2. "General track bulletin No. \_\_\_\_ is void."

An employee must repeat this information to the train dispatcher. If the information is correct, the employee must write "Void" across the first page of the general track bulletin being voided.

## 15.14 Delivering Track Bulletins

Employees who copy track bulletins for delivery must deliver copies to all those addressed, unless the track bulletin is voided or transferred to a relieving employee. When employees have delivered copies to all addressed, they must keep a copy on file.

## 16.0 Rules Applicable Only in Direct Traffic Control (DTC) Limits

### 16.1 Authority to Enter DTC Limits

The timetable will designate DTC limits. A train may enter DTC limits only after receiving authority from the train dispatcher. Men or equipment may be issued DTC authority in the same manner as trains. DTC territory will not include territory where Rule 6.13 (Yard Limits) or Rule 6.14 (Restricted Limits) is in effect.

#### 16.1.1 Switches Between DTC Blocks

Switches between DTC blocks may be occupied only when authority includes at least one block on each side of the switch; however, men or equipment may be authorized to occupy a switch located between DTC blocks without authority on each side of the switch when the DTC authority includes the name of the switch and the instructions "Switch Yes." DTC authority must not be released until the rear of the movement has completely entered the adjoining block.

### 16.2 DTC Authority

The train dispatcher will issue DTC authority to a crew member on the head end of the train when possible. An employee operating the controls of a moving engine or on-track equipment may not copy DTC authority.

#### A. Recorded in Writing

When transmitted verbally, the employee who receives or releases DTC authority must record it in writing and include the following:

1. Name of first and last DTC block where authority is issued.
2. Time that work and time expires.
3. Train identity when DTC authority is issued behind a train or radio blocking behind a preceding train is in effect.
4. Time DTC authority is released to the train dispatcher.

DTC authority must not be transferred to a relieving crew, unless authorized to do so by the train dispatcher.

When verbal authority is received from the train dispatcher to leave equipment in a DTC block, the train dispatcher may instruct a crew member to void the DTC authority.

**Employees cannot act upon DTC authority until the train dispatcher says, "That is correct."**

**B. Multiple Authorities**

Not more than one DTC authority may be issued in the same DTC block except:

1. In ABS territory, as provided by Rule 16.3 (Movement in a Specified Direction), authority may be issued to more than one train in the same direction.
2. As provided by Rule 16.4 (Work and Time).  
or
3. Where radio blocking is designated by special instructions, in non-signalized territory, more than one train may be authorized to proceed in the same direction within the same or overlapping limits, provided the following train:
  - Is notified on DTC authority of the identity of the preceding train.
  - Notifies the crew of the preceding train that radio blocking has been authorized stating the limits.
  - Does not occupy the block limits ahead of the preceding train.
  - Is notified by the preceding train that the entire train has cleared a specific block. Location specified must not be beyond block limits of the following train. The following words must be used: “(Train) clear of (block).”
  - Does not proceed beyond the last block the preceding train has reported to have cleared.

All instructions between trains must be written, repeated, and acknowledged with “That is correct” before being acted on. These written instructions between the trains must be retained until the end of tour of duty.

**Written Instructions Between Trains:**

“(Preceding Train ID) has cleared (Block) at (Time).” When all available lines on DTC form have been filled in, new DTC authority must be obtained.

Notify the train dispatcher if communication cannot be established between the two trains. If necessary, radio blocking information may be relayed only by the train dispatcher.

The last named point of the following train’s authority must not extend beyond the authority of the preceding train.

In the application of Rule 6.4 (Reverse Movements) and Rule 6.6 (Picking Up Crew Member), the movement must not enter the last block reported cleared to the following train.

**16.3 Movement in a Specified Direction****Issue Format**

**One or Two Blocks.** The train dispatcher will issue authority and an employee will acknowledge it using the following sample format:

**Train Dispatcher:** “RR 4321 East, with Engineer Jones, you are authorized to proceed Eastward in one block, Anna.”

**Crew Member:** “RR 4321 East, with Engineer Jones, I am authorized to proceed Eastward in one block, Anna.”

**Train Dispatcher:** “RR 4321 East, that is correct.”

**More than Two Blocks.** The train dispatcher will issue authority in more than two blocks using the following sample format:

**Train Dispatcher:** “RR 4321 East, with Engineer Jones, you are authorized to proceed Eastward in three blocks, Anna through Cloy.”



### 16.3.1 Leaving the Main Track

A train authorized to proceed in one direction must inform the train dispatcher when it leaves the main track before reaching the last named point, unless a crew member is left to prevent a following movement from passing.

## 16.4 Work and Time

### A. Issue Requirements

1. Work and time authority may be issued to an employee in charge of on-track equipment when:
  - The DTC block is clear.
  - The DTC block is occupied by a train and/or employee in charge of on-track equipment that has already been issued work and time. Before joint work and time may be issued, the train dispatcher must first notify the engineer of train or employee in charge of on-track equipment affected that the DTC block will be jointly occupied. All movements must be made at restricted speed within joint work and time limits.

or

  - All trains issued Rule 16.3 (Movement in a Specified Direction) have passed the location where the track will be occupied, and the employee receiving the DTC authority is notified that work and time is granted behind such trains.
2. Work and time authority may be issued to a train when:
  - The DTC block is clear.
  - The DTC block is occupied by a train and/or employee in charge of on-track equipment that has already been issued work and time. Before joint work and time may be issued, the train dispatcher must first notify the engineer of train or employee in charge of on-track equipment affected that the DTC block will be jointly occupied. All movements must be made at restricted speed within joint work and time limits.

or

  - All trains issued Rule 16.3 (Movement in a Specified Direction) have passed the location where the track will be occupied and the employee receiving the DTC authority must be notified that work and time is granted behind such trains as prescribed by Rule 16.2 (DTC Authority).

A train or on-track equipment issued work and time may occupy the designated block and move in either direction.

An employee in charge of on-track equipment granted work and time behind a train must not pass train(s) specified.

### B. Issue Format

**One or Two Blocks.** The train dispatcher will issue work and time and an employee will acknowledge it using the following sample format:

- Train Dispatcher:** “RR 4321 East, with Engineer Jones, I am granting you work and time in one block, Anna, until 10:10 AM.”
- Crew Member:** “RR 4321 East, with Engineer Jones, I am granted work and time in one block, Anna, until 10:10 AM.”
- Train Dispatcher:** “RR 4321 East, that is correct.”

**More than Two Blocks.** The train dispatcher will issue authority in more than two blocks using the following sample format:

**Train Dispatcher:** “RR 4321 East, with Engineer Jones, I am granting you work and time in 3 blocks, Anna through Cloy, until 10:10 AM.”

**Crew Member:** “RR 4321 East, with Engineer Jones, I am granted work and time in three blocks, Anna through Cloy, until 10:10 AM.”

Unless the train and/or employee in charge of on-track equipment receives a time extension, they must clear the block and report “Released” before the time limit expires. The train dispatcher may issue an unspecified time limit by using the words “until released.”

**A train dispatcher must not authorize a train to enter a DTC block under Rule 16.3 (Movement in a Specified Direction) until work and time in that block is released.**

### C. Additional Time

Trains or the employee in charge of on-track equipment must release work and time before the time granted expires. If the train or employee in charge requires additional time, the authority must be obtained from the train dispatcher before time expires. If a train crew member or employee in charge is unable to contact the train dispatcher, and the time limit expires, authority is extended until the train dispatcher is contacted.

## 16.5 Changing DTC Authority

When it becomes necessary to change the authority previously granted to a train, a new authority will be issued in accordance with Rule 16.3 (Movement in a Specified Direction) or Rule 16.4 (Work and Time). After the “(\_\_\_\_\_) , that is correct” response is received from the train dispatcher, the authority previously granted becomes void.

The train dispatcher must notify the engineer before withdrawing previously issued DTC authority.

## 16.6 Releasing DTC Authority

Unless the train dispatcher specifies otherwise, when a train with directional authority clears a DTC block, an employee will immediately release it to the train dispatcher. The train must not re-enter the DTC block it has been released from.

Before a DTC block is released, engineer and conductor must communicate with each other and confirm that their train is clear of DTC block(s) to be released.

### A. Release Format

**One or Two Blocks.** An employee will release a DTC block, and the train dispatcher will acknowledge it using the following sample format:

**Crew Member:** “RR 4321 East, with Engineer Jones, I am releasing one block, Anna.”

**Train Dispatcher:** “RR 4321 East, with Engineer Jones, you are releasing one block, Anna.”

**Crew Member:** “Train dispatcher, that is correct.”

**More than Two Blocks.** An employee will release more than two blocks using the following sample format:

**Crew Member:** “RR 4321 East, with Engineer Jones, I am releasing three blocks, Anna through Cloy.”

**A DTC block is not released until the employee releasing the block reports, “Train dispatcher, that is correct.”**

**B. Operating in Non-Signaled or Double Track Territory**

In non-signaled or double track territory, a train without a crew member on the rear of the train may release a DTC block only when the complete train is clear of the limits, which is determined by one of the following:

1. The rear of the train has an operating rear-end telemetry device, and the air pressure on the head-end device indicates brake pipe continuity.
2. An employee verifies that a marker is on the rear of the train.
3. A crew member can observe the rear car of the train on which the marker has been placed.
4. A trackside warning detector transmits an axle count for the train, and the axle count duplicates the axle count transmitted by the previous trackside warning detector.

In addition, a train clearing in a siding or other track must comply with requirements outlined in Rule 8.3 (Main Track Switches) before reporting clear of the limits.

**16.7 Communication Failure**

If communication fails, a third party may relay the authority to enter and/or release a DTC block as follows:

- The train dispatcher must transmit the DTC authority to the third party.
- The third party must repeat it back to the train dispatcher.
- If correct, the train dispatcher will respond, "(Third Party Identification), that is correct for relay," which authorizes the third party to transmit the DTC authority to a crew member.
- The crew member receiving the DTC authority must repeat it back to the third party.
- If correct, the third party will respond, "(\_\_\_\_\_), that is correct" and inform the train dispatcher that DTC authority has been relayed correctly.

**This page left blank intentionally.**

## 17.0 Rules Applicable Only in Automatic Train Control (ATC) Territory

### 17.1 Automatic Train Control Territory

ATC territory is specified in special instructions. An engine must not be operated in ATC territory if it is not equipped with an operable ATC system unless otherwise authorized by special instructions or the train dispatcher.

### 17.2 Taking Charge

When taking charge of an engine equipped with ATC in ATC territory or entering such territory, engineers must know that:

1. The ATC system is cut in and sealed or locked on engines equipped.
2. The following devices are sealed (on engines equipped) with a mechanical seal:
  - Speed indicator case.
  - Speed indicator cables.
  - High speed whistle cutout cock.

### 17.3 Cut In and Cut Out Requirements

The ATC system, in part or in its entirety, must not be cut out in ATC territory unless:

- Train dispatcher grants permission.
- or
- Failure of the ATC system prevents train movement at restricted speed (unable to recover the air) and crew is unable to immediately contact the train dispatcher. The train dispatcher must be notified as soon as practical. Notification must include if cab signals are operative.

The train dispatcher may grant permission to a crew member to cut out the ATC system when:

- It has failed. Before granting permission to the crew to cut out the ATC the train dispatcher must determine if the cab signals are operative.

or

- Required for movements against the current of traffic at speeds above restricted speed.

#### A. Cutting In ATC

To cut in ATC:

1. Turn on the ATC system.
2. Acknowledge when the acknowledging horn sounds.
3. Cut in the ATC actuator and seal or lock.

#### B. Cutting Out ATC

To cut out ATC:

1. Break the seal or unlock and cut out the ATC actuator.
2. Turn off the power to the ATC system.

If ATC is cut out due to failure enroute, at the next stop the engineer must cut in the ATC to determine if it is again operable. Train dispatcher must be notified if ATC is again operative or continues to fail and if cab signals are operative if previously cut out.

## 17.4 Departure Test Requirements

A departure test is required:

- Before entering ATC territory.
- or
- When the ATC is cut in after being cut out enroute within ATC territory.

### A. Energized Test Loop

While the engine is standing on energized test loop:

1. The cab signal should display a Clear aspect.
2. When the test loop is de-energized or when the engine is moved off of the test loop, the aspect will change to a Restricting and the acknowledging horn will sound. Do not acknowledge the horn and do not move the brake valve handle.
3. A penalty brake application should occur within 8 seconds.
4. Recover the air.
5. When the horn sounds again, acknowledge to prevent a penalty brake application.

Note: To recover the air after an ATC penalty brake application, acknowledge the horn or alarm and move the brake valve handle to SUPPRESSION until the PCS light has gone out. The brakes may then be released.

Receivers on Both Ends: When an engine has ATC receivers on both ends and is standing on energized track, the cab signal should display Clear.

1. Place the reverser in Reverse position. The cab signal will change to Restricting and the acknowledging horn will sound.
2. Do not acknowledge the horn and do not move the brake valve handle. A penalty brake application should occur within 8 seconds.
3. Recover the air.
4. When the horn sounds again, acknowledge to prevent brake application.

### B. De-energized Track

When engine is standing on de-energized track:

1. Release the brakes, but do not acknowledge the acknowledging horn.
2. A penalty brake application should occur within 8 seconds.
3. Recover the air.
4. When the horn sounds again, acknowledge to prevent a penalty brake application.

### 17.4.1 Departure Test Reporting

Records of ATC and ATS tests:

- Must be retained for 92 days.
- Must be placed in the engine cab.
  1. When Mechanical Department employees perform the test:
    - One part of the form must be retained at the test location for 92 days.
    - The other must be placed in the inspection holder in the engine cab.
  2. At points where engineers are required to perform ATC or ATS departure tests, engineers must complete the form, place it in the inspection holder of the engine, and notify the train dispatcher. Crew members are not to remove this form unless specifically instructed to do so.
  3. The train dispatcher, unless instructed otherwise, must record the date, time, location, engine number and name of the engineer.

## 17.5 High Speed Setting

When a cab signal displays a Clear aspect and the train speed exceeds the high-speed setting, a high speed whistle will sound continuously. This will require a SUPPRESSION brake application within 6 seconds to prevent a penalty brake application.

### 17.5.1 Over 40 MPH

The high-speed whistle will sound when the speed is more than 40 MPH when the cab signal changes to a Restricting aspect.

1. Move the brake valve handle to SUPPRESSION within 6 seconds to prevent a penalty brake application.
2. When speed is reduced to less than 40 MPH, the high-speed whistle will stop and the acknowledging horn will sound.
3. Acknowledge this horn. If the cab signal continues to display Restricting, speed must immediately be reduced to restricted speed.

If restricted speed is not reached within 70 seconds after the acknowledging horn was acknowledged, a penalty brake application will occur unless the brake valve handle is in SUPPRESSION.

### 17.5.2 Under 40 MPH

The acknowledging horn will sound if the cab signal changes from Clear to Restricting when the speed is under 40 MPH.

1. Acknowledge the horn within 6 seconds to prevent a penalty brake application.
2. If the cab signal continues to display Restricting, train speed must immediately be reduced to restricted speed.

If restricted speed is not reached within 70 seconds after the acknowledging horn was acknowledged, a penalty brake application will occur unless the brake valve handle is in SUPPRESSION.

### 17.5.3 Restricting Cab Signal

When cab signal changes from a Clear to a Restricting aspect, trains exceeding Restricted Speed must immediately reduce to Restricted Speed. While the cab signal continuously displays a Restricting aspect, the acknowledging horn will sound to alert the crew members of the restriction. When the speed is approaching the restricting over speed setting, the low speed alarm will sound to alert crew members that speed must be reduced.

## 17.6 Conforming with Block Signals

Cab signal indications do not supersede the indication displayed on block and interlocking signals. The most restrictive block or cab signal indication must be complied with. However, when the cab signal changes from Restricting to Clear after having passed the block or interlocking signal, the train may immediately comply with the cab signal indication.

Except where cab signals are capable of displaying diverging route aspects, when initiating movement or when the cab signal changes from Restricting to Clear after the engine passes a signal that governs the approach to a diverging route, the train must approach the next signal at the speed prescribed for the most restrictive route at that location until the next signal is visible.

Note: When the cab signal cycles from Clear to Restricting and immediately back to Clear, the train may continue at normal speed.

### 17.6.1 Approaching Diverging Route

When the cab signal changes from Restricting to Clear after the engine passes a signal displaying an Approach or a more restricting indication and the next signal can display an indication for a diverging route, the train must approach the next signal at the speed prescribed for the most restrictive route at that location. However, if the signal is seen to display an indication for a more favorable route, the speed for that route governs.

## 17.7 ATC Failure/Cut Out Enroute

When any part of the ATC system is cut out enroute:

1. Before an absolute block is established in advance of the train:
  - If cab signals are operative or movement will be entirely in continuous block signal territory, proceed not exceeding 40 MPH.
  - or
  - If cab signals are not operative and movement is outside continuous block signal territory, proceed at restricted speed.
2. After an absolute block is established in advance of a train:
  - If cab signals are operative or movement will be entirely in continuous block signal territory, proceed in accordance with signal indications not exceeding 79 MPH.
  - If cab signals are not operative and movement is outside continuous block signal territory:
    - Passenger trains may proceed not exceeding 59 MPH.
    - Freight trains may proceed not exceeding 49 MPH.



3. Before an absolute block in advance of movement is established in ATC territory the train dispatcher must determine if:
  - The cab signals are operative.
  - The absolute block in advance of movement will be entirely in territory with continuous fixed block signals.
    - a. If the cab signals are operative or the absolute block in advance of movement will be entirely in continuous block signal territory, the train dispatcher may establish an absolute block in advance of movement as provided by Rule 11.1 (Establishing an Absolute Block). Rule 11.2 (Signal Indications with Absolute Block) applies. If the cab signal changes to Restricting, the train must stop.
    - b. If the cab signals are inoperative and any part of the absolute block in advance of movement will be outside continuous block signal territory, the train dispatcher must not establish an absolute block in advance of movement until it is determined that no trains or engines:
      - Occupy the limits ahead of the train being given the absolute block in advance of movement.
      - Will occupy the limits ahead of the train being given the absolute block in advance of movement.
    - c. Rule 9.15 (Track Permit) or Rule 10.3 (Track and Time) establishes an absolute block when not issued joint.

### **17.7.1 Speed Indicator in ATC**

An inoperative or inaccurate speed indicator, as prescribed by Rule 1.39 (Accuracy of Speed Indicator) is considered an ATC failure. Rule 17.7 (ATC Failure/Cut Out Enroute) applies.

### **17.7.2 ATC Motion Light**

If the motion light is not on when the speed is 6 MPH or above, proceed in accordance with the cab signal indication but not to exceed 40 MPH. Rule 17.7 (ATC Failure/Cut Out Enroute) applies.

### **17.7.3 Audible Indicator**

If the audible indicator does not sound when the cab signal changes to a more restrictive indication or continues to sound when the cab signal change is acknowledged, it is considered an ATC failure. Rule 17.7 (ATC Failure/Cut Out Enroute) applies.

## **17.8 Improper Display**

If a cab signal displays Clear when it should display Restricting due to an open switch, occupied block, or other condition, the train must:

- Stop and warn other trains by radio of exact location and status of train.
- Contact the train dispatcher and be governed by his instructions. If the train dispatcher gives permission to proceed, the train must proceed at restricted speed until the train dispatcher establishes an absolute block in advance of movement.

**18.0 Section Reserved**

**19.0 Section Reserved**

**BNSF Amendment—The following chapter is added:**

## **20.0 Occupancy Control System (OCS)**

### **20.1 OCS for Trains and Engines**

In addition to GCOR Rule 6.13 (Yard Limits), the following also applies at locations designated under the individual subdivision special instructions:

#### **Occupying the Main Track**

Before occupying the main track, trains or engines must receive one of the following permissions from the train dispatcher.

- Written OCS,
- Proceed indication on a controlled signal,  
or
- Verbal permission.

Individual subdivision special instructions or general order will designate locations where permission is granted by:

- Controlled Signal Indication. (Movements against the current of traffic may be authorized by controlled signal indication.)
- Verbal Permission. (Movements against the current of traffic may be authorized by verbal permission.)

Written OCS must be used when permission is joint with Maintenance of Way.

OCS does not relieve a train or engine from complying with restricted speed in non-signaled territory.

The employee requesting OCS will state name, occupation, location and train or other identification. The employee will repeat the permission granted. Written OCS must be copied on the prescribed form. If the permission is repeated correctly, the train dispatcher will acknowledge. The train must not move until the engineer understands the OCS granted. Written OCS record must be retained until OCS is released.

Employees must advise the train dispatcher when they are clear of the limits. Exception: Trains or engines clearing OCS limits at a control point are not required to report clear.

Employees releasing OCS must state the following:

- Their name.
- The OCS number being released, if applicable.
- The track limits being released.
- The time OCS limits released.

**Designated Limits**

OCS limits must be designated by specifying track, where required, and exact points such as switches, mile posts, or other identifiable points.

**Direction of Movement**

When trains or engines receive permission to proceed from one point to another, they must move only in the direction specified.

When trains or engines receive permission to work between two specific points, they may move in either direction between those points.

**Same Limits with a Train or Engine**

Before a train or engine receives permission to occupy the same limits with a train or engine working between two locations, a crew member of each train or engine must be notified. When notified, all movements must be made at restricted speed.

**Same Limits with Men or Equipment**

Before a train or engine receives permission to occupy the same limits with men or equipment, the maintenance of way employee in charge and a crew member of the train or engine must be notified. When notified, all movements must be made at restricted speed.

**Permission Expired**

When unable to contact the train dispatcher and OCS permission expires, permission is extended until the train dispatcher can be contacted.

## Abbreviations

Use only the following abbreviations:

**BNSF amended or added abbreviations are enclosed in a box.**

ABS ..... Automatic Block Signal System  
 ACS ..... Automatic Cab Signal System  
 AMTK..... Amtrak

AS..... Absolute Signal

ATC..... Automatic Train Control  
 ATS..... Automatic Train Stop  
 AUTH..... Authority  
 BO ..... Bad Order  
 BRN ..... Branch  
 BRT ..... Block Register Territory  
 C ..... Center  
 C & E ..... Conductor and Engineer

CNT ..... Connection

COFC ..... Container on Flat Car  
 CONDR ..... Conductor  
 CP..... Control Point  
 CTC ..... Centralized Traffic Control  
 DCS ..... Dual Control Switch  
 DISPR..... Dispatcher  
 DIST ..... District  
 DIV..... Division  
 DT..... Double Track  
 DTC ..... Direct Traffic Control  
 E ..... East

EBCS..... Eastbound Controlled Signal  
 EE..... East End

ENG..... Engine  
 ENGR ..... Engineer  
 ESS ..... East Siding Switch  
 EWD ..... Eastward

EXO ..... East Crossover

FRT..... Freight  
 HER..... Head End Restriction  
 IM..... Intermodal  
 JCT..... Junction  
 MAX..... Maximum  
 MMT ..... Multiple Main Track  
 MP ..... Mile Post  
 MPH..... Miles Per Hour  
 MT ..... Main Track  
 MW ..... Maintenance of Way  
 N ..... North

NA..... Not Applicable  
 NBCS..... Northbound Controlled Signal  
 NE..... North End

NO ..... Number

NSS ..... North Siding Switch  
 NWD ..... Northward

NXO..... North Crossover

OK ..... Correct  
 OOS..... Out of Service  
 OPR..... Operator  
 ORIG ..... Originating  
 PSGR ..... Passenger  
 RC ..... Radio Channel  
 RCO..... Remote Control Operator  
 RCZ ..... Remote Control Zone  
 RE..... Region  
 RECD ..... Received

RESTRN... Restriction  
 RL ..... Restricted Limits  
 RP..... Release Point

S ..... South

SBCS..... Southbound Controlled Signal

SDG..... Siding

SE..... South End  
 SS..... Station Sign

SSS ..... South Siding Switch  
 SUB ..... Subdivision  
 SUBDIV ..... Subdivision  
 SUPT ..... Superintendent  
 SW ..... Switch  
 SWD ..... Southward

SW-N ..... Switch No  
 SW-Y ..... Switch Yes  
 SXO ..... South Crossover  
 TFND ..... Track Flags Not Displayed

TOFC..... Trailer on Flat Car  
 TRK ..... Track  
 TRN ..... Train  
 TWC ..... Track Warrant Control  
 W ..... West

WBCS..... Westbound Controlled Signal  
 WE..... West End

WSS ..... West Siding Switch  
 WWD ..... Westward

WXO..... West Crossover

XO ..... Crossover  
 YD..... Yard  
 YL ..... Yard Limits  
 YM ..... Yardmaster

Use the normal abbreviations for names of months.

# Glossary

## ABS

See Automatic Block Signal System.

## Absolute Block

A length of track that no train is permitted to enter while the track is occupied by another train.

## Absolute Signal

A block or interlocking signal without a number plate, or designated by an A marker.

## ACS

See Automatic Cab Signal System.

## Articulated

Permanently connected multiple unit cars that share a common truck.

## ATC Actuator

An ATC brake applying apparatus.

## ATS

See Automatic Train Stop System.

## Automatic Block Signal System (ABS)

A series of consecutive blocks governed by block signals, cab signals, or both. The signals are activated by a train or by certain conditions that affect the block use.

## Automatic Cab Signal System (ACS)

A system that allows cab signals and the cab warning whistle to operate automatically.

## Automatic Train Control (ATC)

A system to enforce compliance with cab and wayside signal indications. If the train exceeds a predetermined speed for a given signal indication and speed is not reduced at a sufficient rate, brakes are automatically applied.

## Automatic Train Stop System (ATS)

A system activated by wayside inductors positioned to apply the brakes automatically until the train stops.

## Block

A length of track:

- between consecutive block signals.
- between a block signal and the end of block system limits.
- or
- in ATC limits the use of which is governed by cab signals and/or block signals.

## Block Register Territory (BRT)

A method of operation in non-signaled territory where trains, men, and equipment are authorized to occupy the main track in limits designated by the timetable.

## Block Signal

A fixed signal at the entrance of a block that governs trains entering and using that block.

## Block System

A block or series of consecutive blocks within ABS, ACS, CTC, or interlocking limits.

## BRT

See Block Register Territory.

## Cab Signal

A signal in the engineer's compartment or cab that indicates a condition affecting train movement. Cab signals are used with interlocking or block signals or without block signals.

## Cars

Railroad cars.

## Centralized Traffic Control (CTC)

A block system that uses block signal indications to authorize train movements.

## Clearance Point

The location closest to a switch where it is safe for equipment, and a person riding the side of equipment unless prohibited, to pass equipment on an adjacent track.

## Conductor

Employee in charge of train or yard movement.

## Control Operator

Employee assigned to operate a CTC or interlocking control machine or authorized to grant track permits.

## Control Point

The location of absolute signals controlled by a control operator.

## Controlled Siding

A siding within CTC or interlocking limits where a signal indication authorizes the siding's use.

## Controlled Signal

An absolute signal controlled by a control operator.

## Crew Member

Conductors, assistant conductors, brakemen, engineers, remote control operators, yard engine foremen, switchmen, and yard helpers.

## Crossings at Grade

Crossings that intersect at the same level.

## Crossover

A track connection between two adjacent tracks, consisting of two switches, which is intended to be used primarily for the purpose of crossing over from one track to the other.

**CTC**

See Centralized Traffic Control.

**Current of Traffic**

The movement of trains in one direction on a main track, as specified by the rules.

**Direct Traffic Control (DTC)**

A DTC block or a series of DTC blocks where the train dispatcher authorizes track occupancy.

**Distant Signal**

A fixed signal outside a block system that governs the approach to a block signal, interlocking signal, or switch point indicator. A distant signal does not indicate conditions that affect track use between the distant signal and block or interlocking signals or between the distant signal and switch point indicator. A distant signal is identified by a D.

**Double Track**

Two main tracks where the current of traffic on one track is in a specified direction and in the opposite direction on the other.

**Dual Control Switch**

A power-operated switch, moveable point frog, or derail that can also be operated by hand.

**DTC**

See Direct Traffic Control.

**DTC Block**

A length of main track specified by name. DTC block name and limits are identified by wayside signs reading, Begin (name) Block and End (name) Block and by mile post location in the timetable.

**Electric Switch Lock**

An electrically controlled lock that restricts the use of a hand-operated switch or derail.

**Engine**

A unit propelled by any form of energy or more than one of these units operated from a single control. Engines are used in train or yard service. Rules that apply to engines also apply to cab control cars.

**Engineer**

Also includes student engineers, firemen, hostlers, and remote control operators.

**Equipment**

Railroad equipment.

**Equipment Fouling a Track**

The end of rolling equipment or on-track maintenance of way equipment left between the clearance point and the switch points leading to the track on which the equipment is standing.

**Fixed Signal**

A signal that is fixed to a location permanently and that indicates a condition affecting train movement.

**Flagman**

Any employee providing flag protection as outlined in Rule 6.19 (Flag Protection) and for other purposes as outlined in the rules.

**Foreman**

Employee in charge of work.

**BNSF Amendment—Glossary term added:****General Track Bulletin**

A notice containing track bulletin restrictions and other conditions affecting train movement.

**Interlocking**

Signal appliances that are interconnected so that each of their movements follows the other in a proper sequence. Interlockings may be operated manually or automatically.

**Interlocking Limits**

The tracks between outer opposing absolute signals of an interlocking.

**Interlocking Signals**

The fixed signals of an interlocking that govern trains using interlocking limits.

**Main Track**

A track extending through yards and between stations that must not be occupied without authority or protection.

**Men or Equipment**

A term referring to Engineering Department employees and their related equipment.

**Multiple Main Tracks**

Two or more main tracks that are used according to the timetable.

**Pilot**

An employee assigned to a train to assist an engineer or conductor who is unfamiliar with the rules or the portion of railroad the train will operate on.

**Proceed Indication**

Any block signal indication that allows a train to proceed without stopping.

**Radio**

As used in these rules it also applies to wireless communication devices when used in railroad operation.

**Radio Blocking**

A method to establish an absolute block for a following train in non-sigaled territory by direct communication with a preceding train.

**RCO**

See Remote Control Operator

**RCZ**

See Remote Control Zone

**Remote Control Operator (RCO)**

An employee who may operate an engine with or without cars by means of a remote control transmitter.

**Remote Control Transmitter**

A device that gives the remote control operator control of a remote control engine.

**Remote Control Zone (RCZ)**

A portion of track(s) within definite limits designated in the timetable special instructions.

**Reverse Movement**

A movement opposite the authorized direction.

**Siding**

A track connected to the main track and used for meeting or passing trains. Location of sidings are shown in the timetable.

**Signal Aspect**

The appearance of a fixed or cab signal.

**Signal Indication**

The action required by the signal aspect.

**Single Track**

A main track where trains are operated in both directions.

**Special Instructions**

Instructions contained in the timetable or other publication.

**Spring Switch**

A switch with a spring mechanism that returns the switch points to the original position after they are trailed through.

**Station**

A place designated by name in the timetable station column.

**Switch Point Indicator**

A light type indicator used during movement over certain switches to show that switch points fit properly.

**Timetable**

A publication with instructions on train, engine, or equipment movement. It also contains other essential information.

**Track Bulletin**

A notice of conditions affecting train movement. It may also authorize movement against the current of traffic where Rule 9.14 (Movement with the Current of Traffic) is in effect.

**Track Occupancy Indicator**

An indicator that tells whether a length of track is occupied or not.

**Trackside Warning Detector**

A device that indicates conditions such as overheated journals, dragging equipment, excess dimensions, shifted loads, high water, or slides.

**Track Warrant Control (TWC)**

A method to authorize train movements or protect men or machines on a main track within specified limits in a territory designated by the timetable.

**Train**

One or more engines coupled, with or without cars, displaying a marker, and authorized to operate on a main track. A term that when used in connection with speed restrictions, flag protection, and the observance of all signals and signal rules also applies to engines.

**Train Coordination**

Working limits established by a roadway worker through the use of a train's authority on a main track or other track where specific authority is required from a control operator or train dispatcher.

**TWC**

See Track Warrant Control.

**Variable Switch**

A switch identified by a V or a bowl painted yellow. When trailed through, the switch points remain lined in the position they were forced.

**Whistle Quiet Zone**

A designated portion of track, that includes road crossing(s) at grade where whistle signal (7) is not regularly sounded.

**Working Limits**

A segment of track within definite boundaries on which movements may be made only as permitted by the employee in charge. Boundaries may be established using mile posts, station signs, timetable locations, or clearly identifiable points.

**Yard**

A system of tracks, other than main tracks and sidings, used for making up trains, storing cars, and other purposes.

**Yard Limits**

A portion of main track designated by yard limit signs and timetable special instructions or a track bulletin.



## Index

### Absence from Duty

- 1.15.....Duty—Reporting or Absence
- 1.16.....Subject to Call

### Accidents

- 1.1.3.....Accidents, Injuries, and Defects
- 1.2.3.....Equipment Inspection
- 1.2.4.....Mechanical Inspection
- 1.2.6.....Statements
- 1.2.7.....Furnishing Information
- 2.10.....Emergency Calls

### ACS

See Automatic Cab Signal System

### Against the Current of Traffic

See Movements Against the Current of Traffic

### Air Brake

- 1.3.1.....Rules, Regulations, and Instructions
- 1.14.....Employee Jurisdiction
- 4.2.....Special Instructions
- 7.11.....Charging Necessary Air Brakes
- 15.6.....Change of General Order, Special Instruction or Rule

### Alcohol

- 1.5.....Drugs and Alcohol

### Altercations

- 1.7.....Altercations

### Altering Equipment

- 1.23.....Altering Equipment

### Appearance

- 1.8.....Appearance

### ATC

See Automatic Train Control

### ATS

See Automatic Train Stop System

### Authority

See Main Track

### Automatic Cab Signal System (ACS)

- 9.10.....Initiating Movement Between Signals
- 11.1.....Establishing Absolute Block
- 11.2.....Signal Indications with Absolute Block
- 11.3.....Broken or Missing Seals
- 13.1.1.....Observation of Signals
- 13.1.2.....Conforming with Block Signals
- 13.1.3.....Does Not Indicate Conditions Ahead
- 13.1.4.....Cab Signals Cut In and Out
- 13.2.1.....Restrictive to More Favorable
- 13.2.2.....Favorable to More Restrictive
- 13.2.3.....Elimination of Audible Indicator
- 13.3.1.....Cab Signal and Block Signal Do Not Agree
- 13.3.2.....Inoperative Cab Signal Device
- 13.3.3.....Movement with an Inoperative Cab Signal Device

### Automatic Interlocking

- 6.16.....Approaching Railroad Crossings, Drawbridges, and End of Multiple Main Track
- 9.9.1.....Approach to Automatic Interlocking
- 9.12.3.....Automatic Interlocking
- 9.19.....Leaving Equipment in Signal Systems

### Automatic Switches

- 8.19.....Automatic Switches

### Automatic Train Control (ATC)

- 9.10.....Initiating Movement Between Signals
- 11.1.....Establishing Absolute Block
- 11.2.....Signal Indications with Absolute Block
- 11.3.....Broken or Missing Seals
- 17.1.....Automatic Train Control Territory
- 17.2.....Taking Charge
- 17.3.....Cut In and Cut Out Requirements
- 17.4.....Departure Test Requirements
- 17.4.1.....Departure Test Reporting
- 17.5.....High Speed Setting
- 17.5.1.....Over 40 MPH
- 17.5.2.....Under 40 MPH
- 17.5.3.....Restricting Cab Signal
- 17.6.....Conforming with Block Signals
- 17.6.1.....Approaching Diverging Route
- 17.7.....ATC Failure / Cut Out Enroute
- 17.7.1.....Speed Indicator in ATC
- 17.7.2.....ATC Motion Light
- 17.7.3.....Audible Indicator
- 17.8.....Improper Display

**Automatic Train Stop (ATS)**

- 11.1..... Establishing Absolute Block
- 11.2..... Signal Indications with Absolute Block
- 11.3..... Broken or Missing Seals
- 12.1..... Required Equipment
- 12.2..... ATS Device Cut Out, Not Equipped, or Not Working
- 12.3.1..... ATS Penalty Brake Application
- 12.3.2..... ATS Inoperative
- 12.3.3..... Damage Inductor
- 12.4.1..... Test Inductor Locations
- 12.4.2..... No Test Inductors

**Automatic Warning Devices**

- 6.32.1..... Providing Warning Over Road Crossings
- 6.32.2..... Automatic Warning Devices
- 6.32.4..... Clear of Crossings and Signal Circuits
- 6.32.5..... Actuating Automatic Warning Devices Unnecessarily

**Bell**

- 5.8.1..... Ringing Engine Bell
- 5.8.3..... Whistle Failure

**Block Register Territory**

- 6.15..... Block Register Territory

**Block Signals**

See Signals

- 2.12..... Fixed Signal Information
- 5.15..... Improperly Displayed Signals
- 5.16..... Observe and Call Signals
- 9.5..... Where Stop Must Be Made
- 9.7..... Failure to Display Most Restrictive Indication
- 9.9..... Train Delayed Within a Block
- 9.9.1..... Approach to Automatic Interlocking
- 9.10..... Initiating Movement Between Signals

**Blue Signal**

- 5.13..... Blue Signal Protection of Workman

**Bowl Tracks**

- 7.13..... Protection of Employees in Bowl Tracks

**Cab Signals**

See Automatic Cab Signal System

- 9.10..... Initiating Movement Between Signals
- 17.5.3..... Restricting Cab Signal

**Call Lights**

- 9.24..... Call Lights

**Careless**

- 1.6..... Conduct

**Cars**

- 1.2.4..... Mechanical Inspection
- 1.20..... Alert to Train Movement
- 1.21..... Occupying Roof
- 1.23..... Altering Equipment
- 1.31..... Repairs to Foreign Cars
- 1.32..... Overheated Wheels
- 1.33..... Inspection of Freight Cars
- 1.34..... Flat Spot
- 1.35..... Dump Doors
- 1.37..... Open Top Loads
- 1.41..... Engines Coupled to Occupied Passenger Cars
- 5.12..... Protection of Occupied Outfit Cars
- 6.5..... Shoving Movements
- 6.20..... Equipment Left on Main Track
- 6.28.3..... Cars or Equipment Left on Siding
- 6.32.4..... Clear of Crossings and Signal Circuits
- 7.4..... Precautions for Coupling or Moving Cars or Engines
- 9.19..... Leaving Equipment in Signal Systems
- 9.20..... Clear Track Circuits
- 9.22..... Standing on Sanded Rail
- 15.5..... Protection When Tracks Blocked with Equipment

**Centralized Traffic Control (CTC)**

See Track and Time

- 6.3.1..... Train Coordination
- 6.4.2..... Movements Within Control Points or Interlockings
- 6.13..... Yard Limits
- 9.5.2..... Protection If Signal Appliance or Track is Damaged
- 9.5.3..... Protection During Repairs
- 9.5.4..... Authority to Proceed
- 9.5.5..... Reporting Delays
- 9.9..... Trains Delayed Within a Block
- 9.12.1..... CTC Territory
- 9.13..... When Instructed to Operate Dual Control Switches by Hand
- 9.13.1..... Hand Operation of Dual Control Switches
- 9.18..... Electrically Locked Switches and Derails
- 10.1..... Authority to Enter CTC Limits
- 10.2..... Clearing Through Hand-Operated Switches

**Change of Direction**

- 6.4.2..... Movement Within Control Point or Interlocking

**Circulars**

- 1.3.3..... Circulars, Instructions, and Notices

**Conduct**

- 1.6..... Conduct

**Conductor**

- 1.47..... Duties of Crew Members

**Continued Employment**

1.1..... Safety

**Controlled Siding**

6.4..... Reverse Movements

6.23..... Emergency Stop or Severe Slack Action

**Control Point**

6.4.2..... Movement Within Control Point or Interlocking

**Control Operators**

1.3.1..... Rules, Regulations, and Instructions

1.45..... Duties of Control Operator and Operators

**Credit**

1.25..... Credit or Property

**Crew Members**

1.47..... Duties of Crew Members

**Crossings**

See Public Crossing

See Railroad Crossing

**Crossover Switches**

8.3..... Main Track Switches

8.12..... Hand-Operated Crossover Switches

8.14..... Conflicting Movements Approaching Switch

**CTC**

See Centralized Traffic Control

9.5.1..... Changing Established Route

**Current of Traffic**

5.4.6..... Display of Flags Within Current of Traffic

6.24..... Movement on Double Track

6.25..... Movement Against the Current of Traffic

9.12.4..... ABS Territory

9.14..... Movement with the Current of Traffic

9.14.1..... Reporting Clear of a Track Having a Current of Traffic

15.3..... Authorizing Movement Against the Current of Traffic

**Damage to Property**

See Railroad Property

**Defects**

1.1.3..... Accidents, Injuries, and Defects

1.2.3..... Equipment Inspection

1.40..... Reporting Engine Defects

6.21.1..... Protection Against Defects

**Delayed Within a Block**

9.9..... Train Delayed Within a Block

9.9.1..... Approach to Automatic Interlocking

**Derails**

See Hand-Operated Switches

8.8..... Switches Equipped with Locks, Hooks or Latches

8.20..... Derail Location and Position

9.18..... Electrically Locked Switches and Derails

**Detoured Trains**

1.42..... Trains Detoured

**Direct Traffic Control (DTC)**

6.3.1..... Train Coordination

6.25..... Movement Against the Current of Traffic

9.12.4..... ABS Territory

16.1..... Authority to Enter DTC Limits

16.2..... DTC Authority

16.3..... Movement in a Specified Direction

16.4..... Work and Time

16.5..... Changing DTC Authority

16.6..... Releasing DTC Authority

16.7..... Communication Failure

**Discourteous**

1.6..... Conduct

**Dishonest**

1.6..... Conduct

**Distant Signals**

8.9.6..... Approaching a Spring Switch in Non-Signaled Territory

**Ditch Lights**

5.9.5..... Displaying Ditch Lights

**Double Track**

5.4.6..... Display of Flags Within Current of Traffic

6.16..... Approaching Railroad Crossings, Drawbridges, and End of Multiple Main Track

6.24..... Movement on Double Track

6.25..... Movement Against the Current of Traffic

6.26..... Use of Multiple Main Track

8.3..... Main Track Switches

9.12.4..... ABS Territory

9.14..... Movement with the Current of Traffic

9.14.1..... Reporting Clear of a Track Having a Current of Traffic

15.3..... Authorizing Movement Against the Current of Traffic

**Drawbridge**

6.16..... Approaching Railroad Crossings, Drawbridges, and End of Multiple Main Track

## **Driving Record**

1.6.1.....Motor Vehicle Driving Records

## **Dropped Cars**

6.32.1.....Providing Warning Over Road Crossings

7.1.....Switching Safely and Efficiently

7.7.....Kicking or Dropping Cars

7.7.1.....Gravity Switch Moves

## **Dual Control Switches**

8.1.....Hand Operation of Switches

8.8.....Switches Equipped with Locks, Hooks or Latches

8.17.....Avoid Sanding Over Moveable Parts

8.19.....Automatic Switches

9.13.....When Instructed to Operate Dual Control Switches by Hand

9.13.1.....Hand Operation of Dual Control Switches

## **Drugs**

1.5.....Drugs and Alcohol

## **DTC**

See Direct Traffic Control

## **Dump Doors**

1.35.....Dump Doors

## **Electrically Locked Switches**

9.18.....Electrically Locked Switches and Derails

## **Emergency**

2.10.....Emergency Calls

## **Emergency Stop**

6.23.....Emergency Stop or Severe Slack Action

## **Employees Working Sign**

5.14.....Signs Protecting Equipment

## **Employment**

1.18.....Unauthorized Employment

## **Engineer**

1.6.1.....Motor Vehicle Driving Records

1.47.....Duties of Crew Members

## **Engines**

1.2.4.....Mechanical Inspection

1.20.....Alert to Train Movement

1.21.....Occupying Roof

1.23.....Altering Equipment

1.29.....Avoiding Delays

1.30.....Riding Engine

1.34.....Flat Spots

1.39.....Accuracy of Speed Indicator

1.40.....Reporting Engine Defects

1.41.....Engines Coupled to Occupied Passenger Cars

5.9.4.....Displaying Headlights Front and Rear

5.9.6.....Displaying Oscillating White Headlight

5.11.....Engine Identifying Number

7.4.....Precautions for Coupling or Moving Cars or Engines

9.20.....Clear Track Circuits

9.22.....Standing on Sanded Rail

## **Equipment**

See Cars

See Engines

1.1.4.....Condition of Equipment and Tools

1.2.3.....Equipment Inspection

1.2.4.....Mechanical Inspection

1.20.....Alert to Train Movement

1.22.....Not Permitted on Equipment

1.23.....Altering Equipment

15.4.....Protection When Tracks Blocked with Equipment

## **Examinations**

1.3.1.....Rules, Regulations, and Instructions

## **Excepted Track**

6.12.....FRA Excepted Track

## **Fire**

1.28.....Fire

## **Fixed Signal**

2.12.....Fixed Signal Information

5.15.....Improperly Displayed Signals

## **Flagmen**

5.2.2.....Signals Used by Employees

## **Flag Protection**

6.19.....Flag Protection

## **Flags**

See Green Flags

See Yellow Flags

See Yellow-Red Flags

See Red Flags

## **FRA Excepted Track**

6.12.....FRA Excepted Track

## **Fusee**

5.6.....Unattended Fusee

## **Games**

1.10.....Games, Reading, or Electronic Devices

**General Order**

- 1.3.1..... Rules, Regulations, and Instructions
- 1.3.2..... General Order
- 4.1.1..... Notice of New Timetable
- 15.6..... Change of General Order, Special Instruction or Rule

**Good Faith Challenge**

- 1.4.1..... Good Faith Challenge

**Gratuities**

- 1.26..... Gratuities

**Green Flags**

- 5.4.2..... Display of Yellow Flag
- 5.4.5..... Display of Green Flag
- 5.4.6..... Display of Flags Within Current of Traffic
- 5.15..... Improperly Displayed Signals

**Hand Brakes**

- 7.4..... Precautions for Coupling or Moving Cars or Engines
- 7.5..... Testing Hand Brakes
- 7.6..... Securing Cars or Engines

**Hand-Operated Switches**

See Main Track Switches

See Spring Switches

- 8.1..... Hand Operation of Switches
- 8.2..... Position of Switches
- 8.8..... Switches Equipped with Locks, Hooks or Latches
- 8.11..... Switches in Sidings
- 8.12..... Hand Operated Crossover Switches
- 8.14..... Conflicting Movements Approaching Switch
- 8.15..... Switches Run Through
- 8.16..... Damage or Defective Switches
- 9.13..... When Instructed to Operate Dual Control Switches by Hand
- 9.13.1..... Hand Operation of Dual Control Switches
- 9.18..... Electrically Locked Switches and Derails

**Hand Signals**

- 5.1..... Signal Equipment
- 5.2..... Receiving and Giving Signals
- 5.2.1..... Looking for Signals
- 5.2.2..... Signals Used by Employees
- 5.3.1..... Hand Signals
- 5.3.2..... Giving Signals
- 5.3.3..... Signal Disappearance
- 5.3.4..... Signal to Stop
- 5.3.5..... Acknowledge Stop Signal
- 5.3.6..... Radio and Voice Communication
- 5.9.1..... Dimming Headlight

**Hazardous Material Instructions**

- 1.3.1..... Rules, Regulations, and Instructions
- 1.14..... Employee Jurisdiction

**Headlight**

- 5.9..... Headlight Display
- 5.9.1..... Dimming Headlight
- 5.9.2..... Headlight Off
- 5.9.3..... Headlight Failure
- 5.9.4..... Displaying Headlights Front and Rear
- 5.9.6..... Display Oscillating White Headlight

**Hours of Service**

- 1.17..... Hours of Service Law
- 15.12..... Relief of Engineer or Conductor During Trip

**Hump Yard**

- 7.13..... Protection of Employees in Bowl Tracks

**Identifying Engine Number**

- 5.11..... Engine Identifying Number

**Immoral**

- 1.6..... Conduct

**Injuries**

- 1.1.2..... Alert and Attentive
- 1.1.3..... Accidents, Injuries, and Defects
- 1.2.1..... Care for Injured
- 1.2.2..... Witnesses
- 1.2.3..... Equipment Inspection
- 1.2.4..... Mechanical Inspection
- 1.2.5..... Reporting
- 1.2.6..... Statements
- 1.2.7..... Furnishing Information
- 2.10..... Emergency Calls

**Information**

- 1.27..... Divulging Information

**Initiating Movement**

- 6.2..... Initiating Movement
- 15.10..... Retaining Track Bulletins

**Inspection**

- 1.2.4..... Mechanical Inspection
- 1.33..... Inspection of Freight Cars
- 6.29.1..... Inspecting Passing Trains
- 6.29.2..... Train Inspections by Crew Members

**Instructions**

- 1.3.1..... Rules, Regulations, and Instructions
- 1.3.3..... Circulars, Instructions, and Notices
- 1.13..... Reporting and Complying with Instructions
- 6.1..... Repeat Instructions

**Insubordinate**

- 1.6..... Conduct
- 1.13..... Reporting and Complying with Instructions

**Interlocking**

- See Manual Interlocking
- See Automatic Interlocking

**Junctions**

- 6.17..... Switches at Junctions
- 6.18..... Stopping Clear of Crossings and Junctions

**Jurisdiction**

- 1.14..... Employee Jurisdiction

**Kicked Cars**

- 6.32.1..... Providing Warning Over Road Crossings
- 7.1..... Switching Safely and Efficiently
- 7.7..... Kicking or Dropping Cars
- 7.7.1..... Gravity Switch Moves

**Main Track**

- See Main Track Authority
- 2.14..... Transmission of Mandatory Directive
- 6.2..... Initiating Movement
- 6.2.1..... Train Location
- 6.3.1..... Train Coordination
- 6.4.1..... Permission for Reverse Movements
- 6.10..... Calling Attention to Restrictions
- 6.11..... Mandatory Directive
- 6.20..... Equipment Left on Main Track
- 6.23..... Emergency Stop or Severe Slack Action
- 9.14.1..... Reporting Clear of a Track Having a Current of Traffic
- 15.5..... Protection When Tracks Blocked with Equipment

**Main Track Authority**

- 6.3..... Main Track Authorization
- 6.13..... Yard Limits
- 6.14..... Restricted Limits (BRT)
- 6.15..... Block Register Territory
- 9.14..... Movement with the Current of Traffic
- 9.15..... Track Permit
- 10.1..... Authority to Enter CTC Limits
- 10.3..... Track and Time
- 14.1..... Authority to Enter TWC Limits
- 16.1..... Authority to Enter DTC Limits
- 16.4..... Work and Time

**Main Track Switches**

- See Spring Switches
- See Dual Control Switches
- 8.3..... Main Track Switches
- 8.4..... Lining Main Track Switch
- 8.5..... Clearing Main Track Before Restoring Switch
- 8.6..... Restoring Switch to Normal Position
- 8.7..... Clearing of Main Track Switches
- 8.8..... Switches Equipped with Locks, Hooks or Latches
- 8.12..... Hand Operated Crossover Switches
- 9.14.1..... Reporting Clear of a Track Having a Current of Traffic
- 9.17..... Entering Main Track at Hand-Operated or Spring Switch
- 10.1..... Authority to Enter CTC Limits
- 10.2..... Clearing Through Hand-Operated Switches
- 14.3.1..... Leaving the Main Track
- 14.7..... Reporting Clear of Limits

**Mandatory Directive**

- 2.14..... Transmission of Mandatory Directives
- 2.14.1..... Verbally Transmitting and Repeating Mandatory Directives
- 6.11..... Mandatory Directive

**Manual Interlocking**

- 6.3..... Main Track Authorization
- 6.4.1..... Permission for Reverse Movement
- 6.4.2..... Movement Within Control Point or Interlocking
- 6.16..... Approaching Railroad Crossings, Drawbridges, and End of Multiple Main Track
- 8.17..... Avoid Sanding Over Moveable Parts
- 9.5.1..... Changing Established Route
- 9.5.2..... Protection If Signal Appliance or Track is Damaged
- 9.5.3..... Protection During Repairs
- 9.5.4..... Authority to Proceed
- 9.5.5..... Reporting Delays
- 9.9..... Train Delayed Within a Block
- 9.12.2..... Manual Interlockings
- 9.13..... When Instructed to Operate Dual Control Switches by Hand
- 9.13.1..... Hand Operation of Dual Control Switches
- 9.18..... Electrically Locked Switches and Derails
- 9.19..... Leaving Equipment in Signal Systems

**Maximum Speed**

- 6.31..... Maximum Authorized Speed

**Marker**

- 5.10..... Marker
- 5.10.1..... Highly Visible Marker
- 5.10.2..... Alternative Markers

**Men Working Sign**

- 5.14..... Signs Protecting Equipment

**Meets**

- 6.8..... Stopping Clear for Meeting or Passing
- 6.9..... Meeting or Passing Precautions

**Misconduct**

- 1.4..... Carrying Out Rules and Reporting Violations

**Motor Vehicle Driving Records**

- 1.6.1..... Motor Vehicle Driving Records

**Movements Against the Current of Traffic**

- 6.13..... Yard Limits
- 6.25..... Movement Against the Current of Traffic
- 14.6..... Movement Against the Current of Traffic
- 15.3..... Authorizing Movement Against the Current of Traffic

**Multiple Main Track**

- 6.16..... Approaching Railroad Crossings, Drawbridges, and End of Multiple Main Track
- 6.26..... Use of Multiple Main Track

**Napping**

- 1.11..... Sleeping
- 1.11.1..... Napping

**Negligence**

- 1.4..... Carrying Out Rules and Reporting Violations
- 1.6..... Conduct

**Notices**

- 1.3.3..... Circulars, Instructions, and Notices

**Obeying the Rules**

- 1.1..... Safety
- 1.3.1..... Rules, Regulations, and Instructions
- 1.4..... Carrying Out Rules and Reporting Violations

**Open Top Loads**

- 1.37..... Open Top Loads
- 1.38..... Shipments Susceptible to Damage
- 7.3..... Additional Switching Precautions

**Operating Rules**

- 1.3.1..... Rules, Regulations, and Instructions
- 1.3.2..... General Order
- 4.2..... Special Instructions
- 15.6..... Change of a General Order, Special Instruction, or Rule

**Oscillating or Flashing Red Light**

- 5.9.7..... Displaying Oscillating or Flashing Red Light

**Oscillating White Headlight**

- 5.9.6..... Displaying Oscillating White Headlight

**Other Than Main Track**

- 6.28..... Movement on Other Than Main Track
- 9.20..... Clear Track Circuits

**Outfit Cars**

- 5.12..... Protection of Occupied Outfit Cars
- 7.9..... Switching Passenger or Occupied Outfit Cars

**Overlap Circuits**

- 9.21..... Overlap Circuits

**Passenger Trains & Cars**

- 1.41..... Engines Coupled to Occupied Passenger Cars
- 6.30..... Receiving or Discharging Passengers
- 7.3..... Additional Switching Precautions
- 7.9..... Switching Passenger or Occupied Outfit Cars

**Passengers**

- 1.2.1..... Care for Injured
- 1.4..... Carrying Out Rules and Reporting Violations

**Passing**

- 6.8..... Stopping Clear for Meeting or Passing
- 6.9..... Meeting or Passing Precautions

**Permanent Speed Signs**

- 5.5..... Permanent Speed Signs

**Personal Injuries**

See Injuries

**Picking Up Crew Member**

- 6.6..... Picking Up Crew Member

**Power-Operated Switch**

See Dual Control Switches

**Practical Jokes**

- 1.7..... Altercations

**Property**

See Railroad Property

**Public Crossings**

- 5.8.1..... Ringing Engine Bell
- 5.8.2..... Sounding Whistle
- 5.8.3..... Whistle Failure
- 5.9.3..... Headlight Failure
- 5.9.5..... Displaying Ditch Lights
- 5.9.6..... Displaying Oscillating White Headlight
- 6.32.1..... Providing Warning Over Road Crossings
- 6.32.2..... Automatic Warning Devices
- 6.32.3..... Providing Warning for Adjacent Tracks
- 6.32.4..... Clear of Crossings and Signal Circuits
- 6.32.5..... Actuating Automatic Warning Devices Unnecessarily
- 6.32.6..... Blocking Public Crossings

**Quarrelsome**

1.6..... Conduct

**Quiet Zone**

See Whistle

**Radio**

- 2.1..... Transmitting
- 2.2..... Required Identification
- 2.3..... Repetition
- 2.4..... Ending Transmission
- 2.5..... Communication Redundancy
- 2.6..... Communication Not Understood or Incomplete
- 2.7..... Monitoring Radio Transmission
- 2.8..... Acknowledgment
- 2.9..... Misuse of Radio Communications
- 2.10..... Emergency Calls
- 2.11..... Prohibited Transmission
- 2.12..... Fixed Signal Information
- 2.14..... Transmission of Mandatory Directives
  - 2.14.1..... Verbally Transmitting and Repeating Mandatory Directives
- 2.15..... Phonetic Alphabet
- 2.16..... Assigned Frequencies
- 2.17..... Radio Testing
- 2.18..... Malfunctioning Radio
- 2.19..... Blasting Operations
- 2.20..... Internal Adjustments
- 5.3.6..... Radio and Voice Communication
- 5.3.7..... Radio Response

**Railroad Crossings**

- 6.16..... Approaching Railroad Crossings, Drawbridges, and End of Multiple Main Track
- 6.18..... Stopping Clear of Crossings and Junctions
- 9.9.1..... Approach to Automatic Interlocking

**Railroad Property**

- 1.2.2..... Witness
- 1.18..... Care of Property
- 1.23..... Altering Equipment
- 1.24..... Clean Property
- 1.25..... Credit or Property

**Reading**

- 1.10..... Games, Reading, or Electronic Devices

**Red Flags**

- 5.4.7..... Display of Red Flag or Red Light
- 5.4.8..... Flag Location
- 5.15..... Improperly Displayed Signals
- 15.2..... Protection by Track Bulletin Form B

**Regulations**

- 1.3.1..... Rules, Regulations, and Instructions
- 1.3.2..... General Order

**Remote Control**

- 5.12..... Position of Occupied Outfit Cars
- 5.13..... Blue Signal Protection of Workmen
- 6.5.1..... Remote Control Movements
- 6.7..... Remote Control Zone
- 7.13..... Protection of Employees in Bowl Tracks

**Repeat of Instructions**

- 6.1..... Repeat Instructions

**Reporting for Duty**

- 1.15..... Duty—Reporting or Absence

**Respect of Railroad Company**

- 1.9..... Respect of Railroad Company

**Restricted Limits**

- 6.14..... Restricted Limits
- 6.25..... Movement Against the Current of Traffic
- 9.12.4..... ABS Territory

**Restricted Speed**

- 6.27..... Movement at Restricted Speed
- 9.10..... Initiating Movement Between Signals
- 9.11..... Movement from Signal Requiring Restricted Speed

**Restrictions**

- 1.47..... Duties of Crew Members

**Retarders**

- 8.17..... Avoid Sanding Over Moveable Parts

**Reverse Movements**

- 6.4..... Reverse Movements
  - 6.4.1..... Permission for Reverse Movement
- 6.6..... Picking Up Crew Member

**Road Crossing**

See Public Crossing

**Rule 9.14 (Current of Traffic)**

- 6.3..... Main Track Authorization
  - 6.3.1..... Train Coordination
- 9.12.4..... ABS Territory

**Rules**

- 1.3.1..... Rules, Regulations, and Instructions
- 15.6..... Change of General Order, Special Instruction or Rule

**Rule Violation**

- 1.2.7..... Furnishing Information



**Safety**

- 1.1..... Safety
- 1.1.1..... Maintaining a Safe Course
- 1.1.2..... Alert and Attentive
- 1.1.3..... Conditions of Equipment and Tools
- 1.3.1..... Rules, Regulations, and Instructions
- 1.4..... Carrying Out Rules and Reporting Violations
- 1.6..... Conduct
- 1.20..... Alert to Train Movement
- 2.6..... Communication Not Understood or Incomplete
- 5.13..... Blue Signal Protection of Workmen

**Safety Rules**

- 1.14..... Employee Jurisdiction
- 4.2..... Special Instructions

**Sanded Rail**

- 9.22..... Standing on Sanded Rail

**Scale Track Switches**

- 8.13..... Scale Track Switches

**Securing Cars or Engines**

See Hand Brakes

**Service Connection Sign**

- 5.14..... Signs Protecting Equipment

**Shoving Cars**

- 6.5..... Shoving Movements
- 6.32.1..... Providing Warning Over Road Crossings

**Siding**

- 6.8..... Stopping Clear for Meeting or Passing
- 6.9..... Meeting or Passing Precautions
- 6.10..... Instructions to Clear a Following Train
- 6.28..... Movement on Other than Main Track
- 6.28.1..... Sidings of Assigned Direction
- 6.28.2..... Stopping Clear in Siding
- 6.28.3..... Cars or Equipment Left on Siding
- 8.11..... Switches in Sidings
- 9.20..... Clear Track Circuits
- 15.5..... Protection When Tracks Blocked with Equipment

**Signals**

- See Fixed Signals
- See Distant Signals
- See Block Signals
- See Cab Signals
- See Hand Signals
- See Signal Indication
- 1.47..... Duties of Crew Members
- 9.1..... Signal Aspects and Indications
- 9.2..... Location of Signals
- 9.3..... What Signals Govern
- 9.4..... Improperly Displayed Signals or Absent Light
- 9.5..... Where Stop Must Be Made
- 9.9..... Train Delayed Within a Block
- 9.10..... Initiating Movement Between Signals
- 9.11..... Movement from Signal Requiring Restricted Speed

**Signal Indication**

- 9.6..... Change of Signal Indication
- 9.7..... Failure to Display Most Restrictive Indication
- 9.8..... Next Governing Signal
- 9.11..... Movement from Signal Requiring Restricted Speed
- 9.12.1..... CTC Territory
- 9.12.2..... Manual Interlockings
- 9.12.3..... Automatic Interlockings
- 9.12.4..... ABS Territory
- 9.16..... Stop and Proceed Indication

**Signs**

- 5.14..... Signs Protecting Equipment

**Sleeping**

- 1.11..... Sleeping
- 1.11.1..... Napping

**Special Instructions**

- 1.3.1..... Rules, Regulations, and Instructions
- 1.3.2..... General Order
- 1.14..... Employee Jurisdiction
- 4.2..... Special Instructions
- 15.6..... Change of a General Order, Special Instruction, and Rule

**Speed Indicator**

- 1.39..... Accuracy of Speed Indicator

**Speed Restrictions**

- 2.14..... Transmission of Mandatory Directives
- 6.11..... Mandatory Directive
- 6.31.1..... Permanent Speed Restrictions

**Speed Signs**

- 5.5..... Permanent Speed Signs

**Spring Switches**

- 8.1..... Hand Operation of Switches
- 8.3..... Main Track Switches
- 8.8..... Switches Equipped with Locks, Hooks or Latches
- 8.9..... Movement Over Spring Switches
  - 8.9.1..... Test Spring Switch
  - 8.9.2..... Trailing Through and Stopping on a Spring Switch
  - 8.9.3..... Hand Operating a Spring Switch Before Making a Trailing Movement
  - 8.9.4..... During Snow or Ice Storms
  - 8.9.5..... Spiking Spring Switch
  - 8.9.6..... Approaching a Spring Switch in Non-Signaled Territory
- 8.10..... Switch Point Indicator
- 8.17..... Avoid Sanding Over Moveable Parts
- 9.17..... Entering Main Track at Hand-Operated or Spring Switch

**Statements**

- 1.2.6..... Statements

**Spur Track**

- 7.12..... Movement Into Spur tracks

**Stop Sign**

- 6.16..... Approaching Railroad Crossings, Drawbridges, and End of Multiple Main Track

**Stop and Proceed Indication**

- 9.16..... Stop and Proceed Indication
- 10.3..... Track and Time

**Stop Signal**

- 5.3.4..... Signal to Stop
- 5.3.5..... Acknowledge Stop Signal
- 5.4.7..... Display of Red Flag or Red Light
- 5.6..... Unattended Fusee
- 9.5..... Where Stop Must Be Made
- 9.6..... Change of Signal Indication
- 9.12.1..... CTC Territory
- 9.12.2..... Manual Interlockings
- 9.12.3..... Automatic Interlockings
- 9.12.4..... ABS Territory
- 9.16..... Stop and Proceed Indication
- 10.1..... Authority to Enter CTC Limits
- 10.3..... Track and Time

**Subject to Call**

- 1.16..... Subject to Call

**Suspension of Block System**

- 9.23..... Suspension of Block System
  - 9.23.1..... Guidelines While Block System is Suspended

**Switches**

- See Crossover Switches
- See Hand-Operated Switches
- See Spring Switches
- See Dual Control Switches
- See Derails
- See Main Track Switches
- See Scale Track Switches
- See Variable Switches
- See Automatic Switches

**Switching**

- See Hand Signals
- 2.2..... Required Identification
- 2.3..... Repetition
- 5.3.6..... Radio and Voice Communications
- 5.3.7..... Radio Response
- 5.9.1..... Dimming Headlight
- 7.1..... Switching Safely and Efficiently
- 7.2..... Communication Between Crews Switching
- 7.3..... Additional Switching Precautions
- 7.4..... Precautions for Coupling or Moving Cars or Engines
- 7.7..... Kicking or Dropping Cars
  - 7.7.1..... Gravity Switch Moves
- 7.8..... Coupling or Moving Cars on Tracks Where Cars are Being Loaded or Unloaded
- 7.9..... Switching Passenger or Occupied Outfit Cars
- 7.10..... Movement Through Gates or Doorways
- 7.11..... Charging Necessary Air Brakes
- 7.12..... Movement Into Spur tracks

**Switch Point Indicator**

- 8.9.6..... Approaching a Spring Switch in Non-Signaled Territory
- 8.10..... Switch Point Indicator

**Tank Car Connected Sign**

- 5.14..... Signs Protecting Equipment

**Timetable**

- 1.3.1..... Rules, Regulations, and Instructions
- 1.14..... Employee Jurisdiction
- 4.1..... New Timetable
  - 4.1.1..... Notice of New Timetable
- 4.3..... Timetable Characters
- 15.6..... Change of a General Order, Special Instruction, and Rule

**Time**

- 1.48..... Time

**Tools**

- 1.1.4..... Condition of Equipment and Tools
- 1.2.3..... Equipment Inspection

**Track and Time**

- 2.14..... Transmission of Mandatory Directives
- 6.11..... Mandatory Directive
- 10.3..... Track and Time
- 10.3.1..... Protection of Limits
- 10.3.2..... Protection of Machines, Track Cars, or Employees
- 10.3.3..... Joint Track and Time
- 10.3.4..... Track and Time Acknowledgment

**Track Bulletin**

- 1.3.1..... Rules, Regulations, and Instructions
- 1.47..... Duties of Crew Members
- 2.14..... Transmission of Mandatory Directives
- 4.1.1..... Notice of New Timetable
- 6.11..... Mandatory Directive
- 15.1..... Track Bulletins
- 15.1.1..... Changing Address of Track Warrants or Track Bulletins
- 15.2..... Protection by Track Bulletin Form B
- 15.3..... Authorizing Movement Against the Current of Traffic
- 15.4..... Protection When Tracks Removed from Service
- 15.5..... Protection When Tracks Blocked with Equipment
- 15.6..... Change of a General Order, Special Instruction, or Rule
- 15.7..... Copying Track Bulletins
- 15.8..... Duplicating Track Bulletins
- 15.9..... Mechanical Transmission of Track Bulletins
- 15.10..... Retaining Track Bulletins
- 15.11..... Restrictions to Crew Members
- 15.12..... Relief of Engineer or Conductor During Trip
- 15.13..... Voiding Track Bulletins
- 15.14..... Delivering Track Bulletins

**Track Occupancy Indicator**

- 9.5.6..... Track Occupancy Indicator

**Track Permits**

- 2.14..... Transmission of Mandatory Directives
- 6.11..... Mandatory Directive
- 6.3.1..... Train Coordination
- 6.13..... Yard Limits
- 6.25..... Movement Against the Current of Traffic
- 9.15..... Track Permit
- 9.15.1..... Issuing Track Permits
- 9.15.2..... Clearing Track Permits

**Track Warrant**

- See Track Warrant Control
- 1.47..... Duties of Crew Members
- 2.14..... Transmission of Mandatory Directives
- 6.11..... Mandatory Directive
- 15.11..... Restrictions to Crew Members
- 15.12..... Relief of Engineer or Conductor During Trip

**Track Warrant Control (TWC)**

- See Track Warrant
- 9.12.4..... ABS Territory
- 14.1..... Authority to Enter TWC Limits
- 14.2..... Designated Limits
- 14.3..... Operating with Track Warrants
- 14.3.1..... Leaving the Main Track
- 14.4..... Occupying Same Track Warrant Limits
- 14.5..... Protecting Men or Equipment
- 14.6..... Movement Against the Current of Traffic
- 14.7..... Reporting Clear of Limits
- 14.8..... Track Warrant Requests
- 14.9..... Copying Track Warrants
- 14.9.1..... Duplicating Track Warrants
- 14.10..... Track Warrant in Effect
- 14.11..... Changing Track Warrants
- 14.13..... Mechanical Transmission of Track Warrants

**Train**

- 1.20..... Alert to Train Movement
- 1.29..... Avoiding Delays
- 1.30..... Riding Engine
- 1.32..... Overheated Wheels
- 1.42..... Trains Detoured
- 1.43..... Stopped in Tunnels
- 2.5..... Communication Redundancy
- 5.10..... Marker
- 5.10.1..... Highly Visible Marker
- 5.10.2..... Alternative Markers
- 5.11..... Engine Identifying Number
- 6.2.1..... Train Location
- 6.10..... Instructions to Clear a Following Train
- 6.21..... Precautions Against Unusual Conditions
- 6.21.1..... Protection Against Defects
- 6.22..... Maintaining Control of Train or Engine
- 6.29.1..... Inspecting Passing Trains
- 6.29.2..... Train Inspections by Crew Members
- 15.7..... Copying Track Bulletins

**Train Coordination**

- 6.3.1..... Train Coordination

**Train Inspection**

- See Inspection

**Train Dispatchers**

- 1.3.1..... Rules, Regulations, and Instructions
- 1.45..... Duties of Train Dispatchers

**Tunnels**

- 1.43..... Stopped in Tunnels

**TWC**

- See Track Warrant Control

**Unauthorized Employment**

- 1.18..... Unauthorized Employment

**Unusual Conditions**

- 6.21.....Precautions Against Unusual Conditions
- 6.21.1.....Protection Against Defects
- 6.21.2.....Water Above Rail

**Utility Employee**

- 5.13.1.....Utility Employees

**Variable Switches**

- 8.10.....Switch Point Indicator
- 8.17.....Avoid Sanding Over Moveable Parts
- 8.18.....Variable Switches

**Voiding Track Bulletins**

- 15.13.....Voiding Track Bulletins

**Violations**

- 1.4.....Carrying Out Rules and Reporting Violations

**Water Above Rail**

- 6.21.2.....Water Above Rail

**Weapons**

- 1.12.....Weapons

**Whistle**

- 5.8.2.....Sounding Whistle
- 5.8.3.....Whistle Failure
- 5.8.4.....Whistle Quiet Zone

**Witness**

- 1.2.2.....Witnesses

**Working Limits**

- 6.3.....Main Track Authorization
- 6.3.1.....Train Coordination
- 6.4.1.....Permission for Reverse Movements

**Wrestle**

- 1.7.....Altercations

**Written Main Track Authorities**

- 6.3.....Main Track Authorization
- 6.11.....Mandatory Directive

**Yardmasters**

- 1.46.....Duties of Yardmasters

**Yard Limits**

- 6.13.....Yard Limits
- 6.25.....Movement Against the Current of Traffic
- 9.12.4.....ABS Territory

**Yellow Flags**

- 5.4.1.....Temporary Restrictions
- 5.4.2.....Display of Yellow Flag
- 5.4.4.....Authorized Protection by Yellow or Yellow-Red Flag
- 5.4.6.....Display of Flags Within Current of Traffic
- 5.4.8.....Flag Location
- 5.15.....Improperly Displayed Signals

**Yellow-Red Flags**

- 5.4.1.....Temporary Restrictions
- 5.4.3.....Display of Yellow-Red Flag
- 5.4.4.....Authorized Protection by Yellow or Yellow-Red Flag
- 5.4.6.....Display of Flags Within Current of Traffic
- 5.4.8.....Flag Location
- 5.15.....Improperly Displayed Signals
- 15.2.....Protection by Track Bulletin Form B